

Alabama School Bus Driver Handbook

Federal and State Laws and Regulations · Driver's Role and Responsibilities · School Bus Braking Systems
Fundamentals of Driving a School Bus · Defensive Driving · First Aid · Accidents and Emergency Evacuations
Transporting Students with Special Needs · Alabama Road Signs



Eric G. Mackey, State Superintendent of Education
Alabama State Department of Education · Student Transportation

REVISED JANUARY 2024

The Alabama School Bus Driver Handbook was developed by the Alabama Department of Education, Pupil Transportation staff including:

Chad Carpenter, Program Administrator

Billy Hollon, Education Administrator

Jerry Lassiter, Financial Administrator

Felicia Toles, Administrative Assistant to the Program Administrator

Jay Bruner, Education Specialist

Brent Copes, Education Specialist

Doug Miles, Education Specialist

Stewart Mosley, Education Specialist

Ward Thigpen, Education Specialist

Bobby Beane, Inspection Program Supervisor

Jerry Harper, State School Bus Inspector

Jerome Cook, State School Bus Inspector

Ladd Cox, State School Bus Inspector

Kenneth Allen, State School Bus Inspector

Jerry Davidson, Transportation Consultant

Mike Morris, Transportation Consultant

Bill Oliver, Transportation Consultant

Jeff Duke, Transportation Inspector Consultant

Obie Fuller, Transportation Inspector Consultant

This handbook is distributed to prospective Alabama school bus drivers for training and testing purposes.

The handbook contains information about state and federal laws, regulations, procedures, guidelines, and recommendations necessary for the safe transportation of Alabama students.

Copies of the handbook are available for a nominal fee from the Alabama Department of Education, Pupil Transportation Section, (334) 694-4545.

The handbook is also available at www.alabamaachievers.org, then by choosing Teachers and Administrators (drop down menu), Transportation, School Bus Driver Handbook.

----- *Table of Contents* -----

Foreword ii
Introduction iii
Requirements to Drive a School Bus in Alabama iv
Chapter 1 - Federal and State Laws and Regulations 1
Chapter 2 - The Driver’s Role and Responsibilities 8
Chapter 3 - School Bus Braking Systems 21
Chapter 4 - Fundamentals of Driving a School Bus 26
Chapter 5 - Defensive Driving 37
Chapter 6 - First Aid 41
Chapter 7 - Accidents and Emergency Evacuations 44
Chapter 8 - Transporting Students with Special Needs 49
Alabama Road Signs 55

Reference

- Alabama Road Signs
- Procedures for Loading, Railroad Crossings, and Backing
- Procedures for Conducting Emergency Evacuation
- Alabama School Bus Driver Skills Test
- School Bus Driver Training Certification

----- Foreword -----

Dear Driver:

Thank you for your interest in becoming an Alabama school bus driver. Alabama school bus statistics indicate that roughly 80% of all school-age children will be transported in a school bus at some point during the school year. Because we are responsible for transporting so many young people, we must always strive for perfection.

Alabama school bus drivers are members of an elite group of drivers, boasting one of our nation's best safety records. Nevertheless, we cannot afford to rest on past accomplishments. Remember that as you drive your school bus, you are constantly making life and death decisions.

Though driving a school bus will at times be very demanding, it will also be very rewarding. Best wishes as you continue to pursue your school bus driving career.

Sincerely,
Eric G. Mackey
State Superintendent of Education
Alabama State Department of Education

----- *Introduction* -----

School bus transportation is an integral part of today's educational system. The school bus driver is expected to present a strong role model for children, as well as represent the school district before the public. If the school bus driver sets an example of good driving practices, his attitude of professional responsibility encourages the development of social responsibility among students. Likewise, good driving practices promote general public confidence in school personnel and programs.

The first and highest priority is the safe delivery of students to and from school. The safety of every student depends on the judgment and skill of the school bus driver. With this in mind, the driver must accept the responsibility for the lives of many young people.

To be a good school bus driver, one must be an informed employee. This handbook has been developed to provide basic facts regarding the operation of school buses for drivers employed by local boards of education in the state of Alabama. Used as an educational tool and reference manual, this handbook presents information which every school bus driver needs to know; however, it is not intended to take the place of any official publication.

Chad Carpenter
Program Administrator
Pupil Transportation
Alabama State Department of Education

Requirements to Drive a Public School Bus in Alabama

Anyone twenty-one years old or older wishing to drive a school bus in the state of Alabama must obtain a Commercial Driver License (CDL) and certification to drive an Alabama school bus through the Alabama State Department of Education (ALSDE).

HOW TO GET A CDL

In order to receive a CDL to drive a school bus, a prospective school bus driver must secure a Commercial Learner Permit (CLP). The CLP can be secured from any CDL office in Alabama. The CLP is given to drivers who do not currently hold a CDL, need to upgrade their CDL, or need to add passenger (P) or school bus (S) endorsements. In order to be issued a CLP, prospective school bus drivers must pass four written CDL tests at the CDL office. These tests include General Knowledge, Air Brakes, Transporting Passengers, and School Buses. CLPs must be obtained 14 days prior to class attendance.

Study materials for these four tests can be found in the Alabama Commercial Driver License Manual. This manual can be secured from any local driver license office or any CDL office. In preparation for the four tests noted above, the prospective driver should study sections 1-5 and section 10 in the CDL manual. There is a fee for taking the written tests. There is no fee for performance testing by ALSDE Examiners. Upon passing these written tests, the prospective driver will be issued a CLP. **The prospective driver must bring their CLP to the ALSDE New School Bus Driver Certification Class, along with their Base Driver's License. Entry Level Driver Training must be completed for the appropriate cdl class, passenger endorsement, & school bus endorsement (theory, btw-range & public road).**

HOW TO OBTAIN CERTIFICATION TO DRIVE AN ALABAMA PUBLIC SCHOOL BUS

In order to receive certification to drive an Alabama public school bus, a prospective school bus driver must meet the following requirements:

1. Establish an AIM account and be put on a class roster.
2. Complete Entry Level Driver Training for each additional Class and Endorsement attaining through Theory and Behind the Wheel-Range and Public Road.
3. Attend a 12-hour ALSDE New School Bus Driver Certification Class taught over a period of three days. Normally, a portion of a fourth day is required for performance testing.
4. Score at least 80% on a written test given at the conclusion of the three-day class.
5. Pass a three-part performance test including:
 - (a) Pretrip inspection of a school bus.
 - (b) Basic Control Skills Tests. These are straight-backing, off-set backing, and alley docking.
 - (c) On-the-Road Driving Skills Test with at least 80% mastery.

All four tests must be passed in consecutive order, beginning with the written test and ending with the on-the-road driving skills test. Once a test is passed, it will not have to be retaken in order to gain initial certification.

All prospective drivers will be allowed only one failure during the process of these four tests. If any of these four tests are failed, the prospective driver will have an opportunity to start again with whichever test they fail. They will have the opportunity to be retrained and attempt the failed test, along with all remaining tests, at a later date. **If the driver fails any of the tests on their second attempt, they will not be allowed to continue, and will not be eligible to become an ALSDE Certified School Bus Driver.**

In order to enroll in an SDE class and be performance tested, all prospective drivers must be assigned to the SDE new driver class by a local school system transportation supervisor. **All CDL performance testing for public school bus drivers is done by ALSDE Examiners.**

HOW TO KEEP YOUR ALABAMA SCHOOL BUS DRIVER CERTIFICATION

All bus driver certificates expire annually on December 31. Drivers who have attended a Recertification class or New Driver Class are certified through the next calendar year. In order to maintain school bus driver certification each calendar year, school bus drivers are required to either:

1. Attend a 4-hour Recertification class.
- or**
2. At the end of the calendar year, if no more Recertification Classes are offered, attend all three days of a New Driver Class and pass the written test.

It is the driver's responsibility to ensure they attend.

Recertification and New Driver classes are scheduled in school systems throughout the state. Drivers who fail to attend a Recertification class or New Driver Class by December 31, and lose their certification, will be required to attend all three days of a New Driver Class, and pass ***all*** tests associated with that class in order to be recertified.

An Alabama school bus driver may have his/her Alabama School Bus Driver Certification suspended and/or revoked when there is a danger to the public safety or welfare of school children or when the certification holder has been guilty of immoral conduct or unbecoming or indecent behavior. This includes, but is not limited to, confirmed improper drug use, criminal convictions, failure to use the driver seat belt, unsafe driving history, inability to pass or maintain a current *Alabama School Bus Driver Physical Examination Report*, being uninsurable, or other just cause as determined by the state superintendent of education.

WHO TO CONTACT: Anyone wishing to drive a school bus in Alabama should contact the local system transportation supervisor. A listing of these supervisors can be found at www.alabamaachieves.org under "Offices/Office of Supporting Programs" or by contacting the Alabama State Department of Education, Pupil Transportation Section at 334-694-4545.

Federal and State Laws and Regulations

There are many laws, rules, and regulations, both State and Federal, which apply generally to all motor vehicles, as well as specific ones which apply only to school buses and their operation. Many of these laws and regulations will be covered throughout this manual under the various areas where they specifically apply.

Alabama Laws

Very few laws have been passed by the legislature of Alabama specifically covering school buses and their operation. Instead, the responsibility for the student transportation system has been delegated to the Alabama State Board of Education and the Alabama State Department of Education. A copy of this law is reproduced here. Many of the elements necessary for the safe transportation of students are contained in this law.

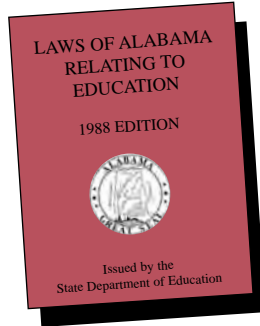

Chapter 27, Title 16, Code of Alabama Transportation of Students

16-27-1 Alabama State Board of Education to prescribe rules and regulations

The Alabama State Board of Education shall prescribe rules and regulations:

- (1) Requiring all local boards of education which provide transportation services for students going to and from public elementary and secondary schools of Alabama or in school-related activities, and the presidents of all state and community, junior and technical institutes, and trade schools which provide transportation services for students going to and from said technical institutes and trade schools or community, junior, and technical colleges to employ a competent supervisor or manager of such transportation services, whether such transportation services are provided in publicly owned or privately owned buses.

- (2) Requiring periodic safety inspection of all vehicles used for transporting students, whether such vehicles are publicly or privately owned.
- (3) Requiring and providing for special training and licensing of drivers of all vehicles used to transport students to and from school and in all school-related activities, whether such vehicles are publicly owned and operated under contract with a private owner.

16-27-2 Transportation of community, junior and technical college, etc., students on public buses

- (a) A student attending a state community, junior and technical college, technical institute or trade school shall be entitled to receive transportation on a public school bus; provided, that no community, junior and technical college, technical institute or trade school bus service is available to such student, such student lives along a route usually served by a public school bus and there is space available in such public school bus for safe operation of additional students.
- (b) The county boards of education whose school buses are being used shall adopt such rules and regulations necessary to carry out the provisions and intent of this section.

16-27-3 Safety inspections by state school bus inspectors; reporting and remedying deficiencies; records and reports

- (a) Safety inspections provided for in the rules herein above mentioned shall be made by authorized, qualified state department of education employees and shall be made at least once each year and more often when, in judgment of the State Superintendent of Education, such inspections should be made. The State Director of Public Safety shall advise and consult with the State Department of Education relative to the type and manner of inspections to be made and the scheduling thereof. When a safety check by a state school bus inspector indicates that a bus

does not meet the safety standards set up by the Alabama State Board of Education, the inspector shall immediately report this fact to the local board of education using such bus. The report shall define the deficiency and prescribe the immediate status of the bus regarding its use; and any bus found by the inspector to be unsafe for operation shall not be used to transport students until appropriate repairs have been made. Any restrictions placed on a bus by an official inspector can be lifted only:

- (1) when a follow-up inspection reveals that the deficiency has been removed; or
- (2) when the local superintendent of education certifies to the state department of education that the prescribed repairs or corrections have been made.
- (3) Records and reports relative to such inspections and corrections shall be made on forms prescribed by the Alabama State Board of Education. Such records and reports shall be maintained on file by the local board of education for a minimum period of one year.

16-27-4 Licensing of Drivers

Regulations made pursuant to an order of the board of education requiring and providing for special training and certification of drivers of vehicles used to transport students to and from school shall require an applicant for a school bus driver certificate to be the holder of a currently valid commercial driver license and to complete a minimum of 12 clock hours of approved instruction in school bus driving and to pass satisfactorily a written examination and also a driving performance test. The written examination shall be designed by the State Superintendent of Education with the cooperation of the State Director of Public Safety or a state trooper or any other representative of the State Department of Public Safety as the State Superintendent of Education and the Director of Public Safety agree, but the driving performance test shall be given by a state trooper or other representative of the State Department of Public Safety. The plan for the performance test shall, however, be submitted to and approved by the State Superintendent of Education before the performance test is given. If the applicant for a school bus driver certificate satisfactorily

passes the test, the testing officer shall report this fact to the State Superintendent of Education and shall send a copy of such report to the local superintendent of education of the county or city where the applicant desires a job as a school bus driver.

Upon receipt of the testing officer's report of an applicant having satisfactorily passed the examinations, the State Superintendent of Education shall issue a special school bus driver certificate. Certificates are valid for up to one year from date of issue. All certificates expire annually on December 31 and may be renewed for an additional year if the applicant attends a four clock-hour training session for school bus drivers conducted in such manner as the State Superintendent of Education prescribes. Such rules may also provide for the issuance of temporary permits or certificates for school bus drivers who have had a minimum of four clock hours of instruction conducted by representatives of a local board of education. Holders of such temporary certificates shall be employed only for the purpose of filling vacancies which develop between scheduled training periods, and such temporary certificates shall be valid for a maximum of six months only.

16-27-5 Monthly Safety Inspections

All local boards of education, all presidents of state community, junior and technical colleges, and all directors of state technical institutes and trade schools which provide transportation services for students or students going to and from public elementary and secondary schools, community, junior and technical colleges or technical institutes and trade schools, and in school or college-related activities shall have safety inspections made of all vehicles used for such transportation at least once each month, whether such vehicles are publicly owned and operated or privately owned and operated under contract between the board of education, board of trustees or other governing body of a community, junior and technical college and the owner of vehicle. All safety inspections made hereunder shall be made by qualified mechanics in accordance with standards and rules established by the Alabama State Board of Education.

16-27-6 Seatbelts

No school bus shall be operated on a public street, highway or elsewhere unless it shall be equipped with a seatbelt for the driver.

The driver of a school bus shall wear a properly fastened seat belt at all times. Failure of a bus driver to comply with this requirement shall be prima facie evidence of nonfeasance of duty, and any driver who fails to comply with this requirement shall be subject to dismissal.

Every contract between a board of education and a school bus contract operator shall contain a clause requiring the driver of a school bus to wear a properly fastened seat belt when the bus is being used for the transporting of students on a public street or highway or elsewhere. Failure of any driver to comply with this requirement shall constitute a breach of contract on the part of the contract operator.

16-27-7 Liability Insurance

The Alabama State Board of Education, each governing board of Alabama public senior universities, and each city and county board of education shall provide vehicle liability insurance for bus drivers or any other employee who is required to transport students. Said vehicle liability insurance shall cover personal liabilities of bus drivers or any other employee who is required to transport students. Said liability insurance shall be applicable to moving vehicular accidents only.

School boards and other agencies covered by this section shall be deemed to be in compliance with the requirements of this section by either purchasing a liability insurance policy naming drivers as insured, or if the employing board elects not to purchase a policy, by reimbursing individual employees for amounts necessary to add “drive other car broad form liability” riders to their individual vehicle liability insurance policies, to the limits specified by the employing board or agency.

The provisions of this section shall also apply to the Alabama Department of Youth Services and the Alabama Institute for the Deaf and Blind. (Acts 1984, No. 84-191, p.300)

Other Alabama Laws

Alabama’s motor vehicle laws are all primarily covered in Title 32, Code of Alabama. These laws apply to all motor vehicles including school buses. Since it is impossible and not necessary to discuss all these laws, only the laws which specifically apply to school buses or school bus drivers will be mentioned.

Overtaking and Passing of a School Bus

When a motorist encounters a school bus that has stopped to pick-up or drop off children on a highway, roadway, school property or private road, the driver must come to a complete stop. Whether meeting the bus head on or attempting to go around either side, if there is a



visual signal as specified in Act # 2006-311, the motorist cannot proceed until the school bus resumes motion, the visual signals are no longer actuated, or until the motorist is signaled by the school bus driver to proceed.

On a divided highway with four or more lanes, which permits at least two lanes of traffic to travel in opposite directions, motorists do not have to stop when meeting a school bus that is loading or unloading in the opposing roadway. Nor does a motorist have to stop if the school bus is stopped in a loading zone which is a part of or adjacent to a highway where pedestrians are not permitted to cross the roadway. A divided highway is defined as a highway where the lanes are separated by an object intended to impede traffic from crossing.

If a driver illegally passes a school bus while the bus is stopped and the red flashing lights are activated, the school bus driver may report the offender to local police authorities. The offender may be determined by using the driver license plate number or by the bus driver being able to personally identify the driver. The red flashing lights should only be used during load or unloading.

The Charles (Chuck) Poland, Jr. Alabama Act 2013-347 – Trespass on a School Bus

makes it a Class “A” misdemeanor to trespass on a school bus. Such offenses include a punishment of up to a year in jail.

Unauthorized entry on Alabama school buses has increased dramatically in recent years. The Charles “Chuck” Poland, Jr. Act specifically addresses the issue of trespassing on an Alabama school bus and will help school

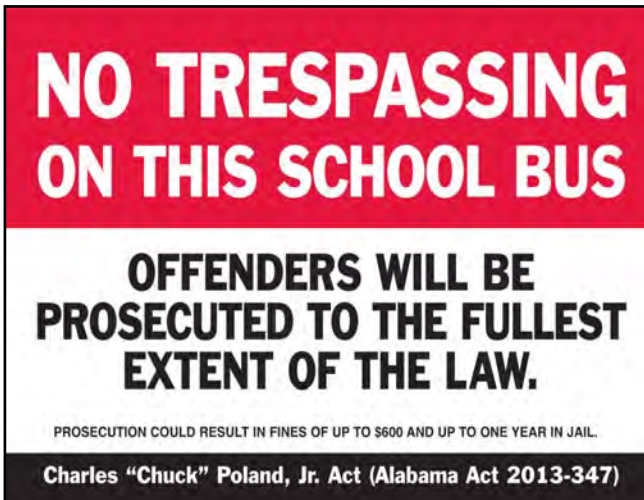

systems protect students and school bus drivers by vigorously prosecuting persons who do so.

A person commits the crime of trespass on a school bus in the first degree if they are found guilty of any of the following:

- Intentionally demolishing, destroying, defacing, injuring, burning, or damaging any public school bus.
- Entering a public school bus while the door is open to load or unload students without lawful purpose while at a railroad grade crossing or after being forbidden from doing so by the bus driver in charge of the bus or an authorized school official.
- An occupant of a public school bus refusing to leave the bus after the bus driver in charge of the bus or authorized school official demands that they do so.
- Intentionally stopping, impeding, delaying, or detaining any school bus from being operated for public school purposes with the intent to commit a crime.

Alabama Act 2012-291 – No Texting makes it illegal to write, send, or read a text-based communication while driving.

The **Lieutenant Dexter Holcomb Act 2012-372 – School Bus Driver Physicals** requires all Alabama school bus drivers to meet certain physical criteria by successfully passing a physical examination by a licensed physician. The driver may choose to obtain a USDOT Medical Examiner’s Certificate or have an Alabama School Bus Driver Physical Form on file with their local education agency.

Background Checks

The Alabama Child Protection Act of 1999 requires state and national criminal history background checks on all first-time teachers and support personnel in both public and nonpublic schools (99-361). This act includes all newly-hired school bus drivers and certain other employees.

This act was passed by the Alabama Legislature to aid in protecting children from persons who may inflict physical or mental injury, abuse, sexual abuse, exploitation or maltreatment, or other mistreatment upon them.

All Alabama school systems are required to comply with this act. Therefore, all newly employed bus drivers and certain other employees must be fingerprinted and a background check must be conducted.

All school bus drivers are responsible for referring to the Alabama Driver’s Manual issued by ALEA for additional information pertaining to the control and safe operation of motor vehicles in general as well as school buses.

Federal Laws

The National Highway Traffic Safety Administration (NHTSA), Department of Transportation, has issued a highway safety program to all states known as **Guideline 17**, which “is designed to improve state programs for transporting students safely in urban and rural areas by setting requirements for proper and safe equipment; maintenance of equipment; selection, training and supervision of drivers and maintenance personnel; and administrative provisions in the field of pupil transportation.” The State of Alabama has accepted, adopted and is using **Guideline 17** in their pupil transportation program. Many of the areas covered in **Guideline 17** are the responsibility of supervisors at the State and system level. The following are selected portions of **Guideline 17**: Different federal agencies have given a variety of definitions to what they consider a school bus to be legally. Generally, the accepted definition is as follows: **All vehicles which are designed to carry more than 10 passengers, including the driver, and which are sold for purposes that include carrying students to and from school or related events.**

The compliance with and enforcement of most of these rules are not the direct responsibility of the individual driver. However, general knowledge of these requirements by the driver can help improve and maintain a high level of safety and efficiency by reporting any discrepancies to the appropriate supervisor.

Guideline 17 states that anyone who drives a school bus should have as a minimum, a valid driver license and meet specific physical, mental, and moral requirements as established by the State Superintendent of Education. Prospective drivers should discuss past traffic records with the local transportation supervisor.

A school bus must be identified with the words “**School Bus**” in letters not less than 8 inches high located between the signal lamps in the front and back of the bus located as high as practical with no other lettering on the front and back of the bus. The bus should be painted National School Bus Glossy Yellow except for the bumpers, which shall be lusterless black.

Guideline 17 also requires buses to have a system of signal lights as are currently on Alabama school buses. The bus must also have a system of mirrors that will give the seated driver a view of the roadway to each side of the bus, and of the area immediately in front of the front bumper.

When a school bus is being operated on a public highway and is transporting primarily passengers other than school students, it should have the words “School Bus” covered, removed, or otherwise concealed, and the stop sign and student loading/unloading signal lamps should not be used.

Guideline 17 also covers many other areas of concern which can lead to a safer pupil transportation system. One such requirement is that each pupil transported in a school bus should be instructed in safe riding practices, and should participate in emergency evacuation drills at least twice during the school year.

Under the general heading of vehicle operation and maintenance, **Guideline 17** requires the State of Alabama to develop plans for minimizing highway hazards to school bus occupants in many ways including, but not limited to:

- Careful planning and annual review of routes for safety hazards.
- Providing loading and unloading zones off the main traveled part of highways, wherever it is practical to do so.

- Establishing restricted loading and unloading areas for school buses at or near schools.
- Requiring the driver of a vehicle meeting or overtaking a school bus that is stopped on a highway to load or unload students to stop his vehicle before it reaches the school bus and not proceed until the warning signals are deactivated.
- Prohibiting, by legislation or regulation, the operation of any vehicle displaying the words, “School Bus” unless it meets the equipment and identification requirements of this standard.



- Prohibiting the use of red warning lights and stop sign for any purpose, and at any time other than when the school vehicle is stopped to load or unload passengers.
- Bus routing and seating plans shall be coordinated in such a way to eliminate standees when a school vehicle is in motion.
- Eliminating any auxiliary seating accommodations such as temporary or folding jump seats in school vehicles.
- Requiring drivers of school vehicles to wear occupant restraints (seatbelts) whenever the vehicle is in motion.
- Local school officials should establish passenger vehicle loading and unloading points at schools that are separate from school bus loading zones

Regardless of who sets the safety and operating standards or who is legally responsible for them, it is the school bus driver’s responsibility to see that the rules and regulations are carried out. The school bus driver has the responsibility and obligation to work within these rules and report any known violation to a supervisor.

Commercial Driver License

On October 26, 1986, Congress passed the Commercial Motor Vehicle Safety Act of 1986.

The law requires states to meet the same minimum standards for commercial driver licensing. The standards require commercial motor vehicle drivers to get a commercial driver license (CDL). You must have a CDL to operate any of the following commercial motor vehicles (CMVs):

- (a) A single vehicle with a gross vehicle weight rating (GVWR) of more than 26,000 pounds.
- (b) A trailer with a GVWR of more than 10,000 pounds if the gross combination weight rating is more than 26,000 pounds.
- (c) A vehicle designed to transport more than 15 people (including the driver).
- (d) Any size vehicle that requires hazardous materials placards.

Commercial Driver License Tests

Knowledge Tests

You will have to take one or more written knowledge tests, depending on what class of license and what endorsements you need. The CDL knowledge tests include:

- **The General Knowledge Test**, taken by all applicants.
- **The Passenger Transport Test**, taken by all bus driver applicants.
- **The Air Brakes Test**, taken if your vehicle has air brakes.
- **The School Bus Test**, taken by drivers needing a school bus endorsement (49 CFR 383.3).

When you pass the required knowledge tests and have purchased a Learner's Permit/License, you can take the CDL skills tests. There are three types of CDL skills tests: the pre-trip inspection test, the basic control skills test, and the road test. These are described below. You must take these tests in the type of vehicle for which you wish to be licensed.

Pre-Trip Inspection

Purpose: To see if you know if the vehicle is safe to drive.

Test Procedure: You will be asked to do a pre-trip inspection of your vehicle or to explain to the instructor what you would inspect and why. The instructor will mark on a scoring form each item that you correctly inspect or explain.

Basic Control Skills Test

Purpose: To evaluate three basic skills in controlling the vehicle.

Set-Up: The test set-up consists of various exercises marked out by lines, traffic cones, or something similar. The exercises include straight-line backing, off-set backing, and alley docking.

The instructor will explain to you how each exercise is to be done. You will be scored on how well you stay within the exercise boundaries and how many pull-ups and looks you make when backing.

Road Test

Purpose: To evaluate your ability to drive safely in a variety of on-the-road situations.

Test Procedure: The test drive is taken over a route specified by the instructor. It may include left and right turns, intersections, railway crossings, curves, up and down grades, rural or semi-rural roads, city multilane streets, expressway driving, loading and unloading students, R/R crossing, and emergency stopping.

Post Trip

- Take key
- Lock Down
- Check for Students

You will drive over the test route following instructions given by the instructor. The instructor will score specific tasks, such as turns, merging into traffic, lane changes, and speed control, at specific places along the route. The instructor will also score whether you correctly do tasks such as signaling, searching for hazards, controlling speed, and lane positioning.

Alcohol and Other Drug Testing

The Omnibus Transportation Employee Testing Act of 1991 requires alcohol and drug testing of safety-sensitive employees in the aviation, motor carrier, railroad, and mass transit industries. This Act did not include bus drivers. However, Part 382, Title 49 was added to the Act which does include school bus drivers. Final guidelines were issued on February 15, 1994.

These are five possible tests involved:

- 1. Pre-employment;**
- 2. Post-accident;**
- 3. Reasonable suspicion;**
- 4. Random;**
- 5. Return to duty/follow-up.**

The Federal Drug and Alcohol Clearinghouse was implemented on January 6, 2020. As a school bus driver, you are required to register in this database and meet all applicable terms and conditions

Other Safety Act Rules

There are other Commercial Motor Vehicle Safety Act rules that affect drivers.

- All states will be connected to one computerized system to share information about CDL drivers. The states will check drivers' accident records and verify that drivers do not get more than one CDL.
- Anyone who holds a CDL automatically agrees to chemical analysis. Consent is implied by driving a commercial motor vehicle on the streets and highways of Alabama. Any driver who willfully refuses a chemical analysis will lose their driving privilege immediately for 90 days and if he/she has an alcohol concentration of 0.04 percent or more, the driver will be disqualified from driving a CMV (commercial motor vehicle) for one (1) year. A driver will lose his/her license for life upon conviction of a second offense. If the driver's alcohol concentration is less than 0.04 percent but has any detectable amount on their breath, he/she will be put out of service for 24 hours.
- The driver must notify his/her employer within 30 days of a conviction for any moving traffic violation. This is true no matter what type of vehicle he/she was driving at the time the citation was issued.
- The driver must notify his/her employer if their license is suspended, revoked, canceled, or disqualified from driving.
- Upon applying for a position requiring a CDL, the driver must give his/her employer information on all commercial driving jobs held for the past 10 years.
- The driver's employer cannot knowingly let a driver drive a commercial motor vehicle if he/she has more than one license or if their CDL has been suspended or revoked.

Test on Laws and Regulations

True or False

- | | |
|--|---|
| _____ 1. Guideline 17 is a State guide issued to the individual school bus drivers covering student discipline. | _____ 7. Alabama school bus drivers are not required to have a criminal background check. |
| _____ 2. A minimum of 12 clock hours of instruction, passing a written test and driving tests are required before a person can become a certified school bus driver. | _____ 8. Alabama school bus drivers must successfully pass a physical before they are eligible to drive a school bus. |
| _____ 3. It is the school bus driver's responsibility to attend a SDE class each calendar year. | _____ 9. State law requires that traffic stop for school buses loading or unloading only on two-lane roadways. |
| _____ 4. The Basic Control Skills Tests include straight-line backing, parallel parking, and alley docking. | _____ 10. The requirements to drive a school bus in Alabama include having a valid commercial driver license, being 21 years old or older, and possessing an Alabama School Bus Driver Certificate. |
| _____ 5. A driver's first DUI conviction, even while driving their personal vehicle, will result in losing their commercial driver license for one year. | _____ 11. School bus drivers are not required to take an alcohol or drug test. |
| _____ 6. A school bus driver could lose his/her job by driving the bus without wearing a seat belt. | _____ 12. School bus drivers must have a CDL in addition to a regular driver license. |

The Driver's Role and Responsibilities



School bus drivers are the most important people in school bus transportation. The safety of their passengers must always be their top priority. Dedicated and committed school bus drivers are essential to safe school transportation. School bus drivers should be of high moral character. They should always conduct themselves in such a manner that their actions on and off duty will not be open to criticism. As a model for their passengers and a representative of the school system, their conduct and appearance should contribute to mutual respect and pleasant relations with their passengers, parents, and fellow motorists.

In addition to skill and knowledge, drivers must have a sound, wholesome attitude about the responsibilities of a school bus driver. A person with a good attitude usually makes a good driver. Poor attitudes usually produce poor drivers.

The driver is the most important person in school bus transportation.

The safety of your passengers is in your hands.

School bus drivers must be mentally alert at all times. They must keep their concentration on what they are doing, and be prepared for any emergency.

A school bus driver must be a defensive driver. A defensive driver is careful not to commit driving errors; who makes allowances for the lack of skill, lack of knowledge, or improper attitude on the part of the other driver; and who does not allow hazards of weather and road conditions or the actions of pedestrians and other drivers to involve him in accidents. He keeps continually on the alert, recognizes an accident-producing situation far enough in advance to apply the necessary preventive action, and yields right-of-way whenever necessary to prevent or avoid an accident.



A defensive school bus driver must exercise self-control, alertness, foresight, judgment, and skill in handling and maintaining control of the bus at all times. A good attitude about defensive driving and safety procedures is the best guarantee of the safest trip possible.

The bus driver's basic responsibility is to transport students to and from school safely.

The school bus driver shall not use or allow the use of a school bus for any purpose other than transporting assigned passengers to and from school for a regularly organized school day unless directed by the supervisor. In transporting assigned passengers, the following rules should be observed:

1. Load or unload a passenger only at regularly designated stops except upon permission of the parent and the principal.
2. Allow only assigned passengers to ride the bus unless permission is granted by the principal or transportation supervisor.
3. Refrain from stopping along the bus route at stores and service stations unless those locations are the regularly designated stops.

4. Drive the bus directly to its regular parking place after the last passenger has been unloaded. Stopping on the way home is not allowed.
5. Don't smoke, chew tobacco, eat or drink anything while driving. The driver is not allowed to use radios, taper recorders, cell phones, or other electronic devices unless it has been approved by local board policy.

These requirements may necessitate extra effort on the part of the driver, but they are essential to a safe and pleasant trip. Schools operate on a regular schedule, and promptness in arriving at school shows dependability and builds good will with students, parents, and principals.

Since the safety of the students is the greatest concern, drivers need to consider every possible variable that may become a safety liability. One of those variables is the type of footwear and/or clothing a bus driver chooses to wear while driving. Footwear that is backless and/or does not cover the entire foot could cause the driver to become distracted and involved in a collision. Types of footwear that may cause distractions are flop-flops, sandals, backless "Berks", etc. Bulky gloves, coats, hats, and large jewelry can also be safety hazards. School bus drivers should check local school system dress codes.

Another variable school bus drivers need to consider is objects brought onto the bus by students. Any object allowed onto the bus should also be kept out of the aisle or seats adjacent to emergency exits. Some objects such as band instruments, student projects, balloons/flowers, etc., may be so large that they distract the driver or block the driver's view. School bus drivers need to check local school system policy as to what will and will not be allowed on the school bus.

Operating on Schedule

The secret of operating on schedule is to leave home at the same time each morning, drive at a safe speed, encourage passengers to be prompt, and stop at all student pick-up points on the way to school. The following procedures will help you, the driver, to maintain the schedule:



1. Time yourself so you can arrive at stops about the same time every morning.
2. Arrive at school each morning at the same time. Time of arrival will be at the direction of the principal.
3. Unusual weather or road conditions will require more time than usual. When these conditions exist, advise students of schedule changes.
4. If late, do not try to make up lost time by driving faster than a safe speed.
5. Encourage students to be prompt. They should be at their designated stop, ready to board the bus when it arrives.

Maintaining Proper Passenger Conduct

If drivers explain existing rules at the beginning of the school year, they usually will have the cooperation of students. If students know drivers are fair and have their safety in mind, they usually accept the rules. Drivers should recognize each child's individuality. Drivers cannot maintain discipline and respect if they are too harsh or too lenient. Drivers who handle problems fairly and according to the rules get the respect of students, parents and administrators.

Be Assertive!

ASSERTIVE BUS DRIVERS ...

- Are the boss on the bus.
- Say what they mean and mean what they say.
- Clearly and firmly tell students exactly how they want them to behave.
- Stay calm and use a normal tone of voice.
- Have a plan of action when students do not behave.
- Reward students when they do behave.

Assertive Discipline for Bus Drivers, Lee Canter and Associates

Student Conduct

It is a fact that children are affected by specific experiences arising from riding your school bus. These experiences, good and bad, become an important part of the total education experience.

The school day starts when a student enters your bus and extends until that student is safely off your bus in the afternoon.

Undesirable conduct not only makes all passengers uncomfortable, but it jeopardizes their safety. Rules of conduct should be reasonable and infractions dealt with promptly, firmly, and fairly.



While the use of negative terms when dealing with bad behavior may be common place, it makes a lot more sense to reinforce good behavior with positive terms. Learn to recognize behaviors that are desirable and “reward” them with positive responses. For example, “Thank you, Ken, for picking up that piece of paper.” “Good for you, Brecca,

you had everyone lined up in the right place this morning. I appreciate that.” Any of us who will learn to accentuate the positive will eliminate the negative.



Most school systems will have rules and policies set by the local board. Study them,

follow them and make your students aware of the rules. Some general rules that are standard across the state are:

1. **Students must get on and off the school bus at designated stops and in an orderly manner according to local board policy. No pushing, shoving, or letting a student off at a store on the way home.**
2. **Students should be allowed to talk but not loud enough to distract the driver. If you have to worry about the activity on the bus, you cannot be a safe driver.**
3. **Students will remain seated until the bus is stopped.**
4. **Students will keep their arms or any part of their body inside the bus.**
5. **Nothing will be thrown from the school bus.**
6. **The ALSDE recommends that students arrive at designated stop 5 minutes prior to scheduled pick-up.**



Your main function is to take a student from point A to point B without conflict. Never threaten an action you cannot enforce; rather, win your way by friendly persuasion. If you overlook violence by one child, you lose the respect of others. Try to hit a happy medium, having a friendly, cheerful, and business-like attitude. The students will reflect the attitude of the driver.

Remember the Do's and Don'ts:

Do:

- ✓ Be firm, fair, impartial, and consistent.
- ✓ Keep your cool. Never lose your temper.
- ✓ Treat students as you would like your child to be treated.
- ✓ Set a good example in appearance and driving habit.

Don't:

- ✓ Embarrass students.
- ✓ Make threats you cannot carry out.
- ✓ Put your hands on a student.
- ✓ Use profanity.
- ✓ Hold grudges.
- ✓ Create issues that have to be settled later.



Standing Passengers

No passenger should be standing on a school bus. During the first few days of school, you may have more passengers than seats. This problem should be reported and corrected immediately. All passengers should be seated entirely within the confines of the school bus seats while the bus is in motion.

Routing and seating plans should be coordinated to eliminate passengers standing when a school bus is in motion (**Guideline 17**). Federal regulations do not specify the number of persons that can sit on a school bus seat. The school bus manufacturers determine the maximum seating capacity of a school bus. Due to the variation in sizes of children of different ages, state and school districts should exercise judgment in deciding how many students are actually transported in a school bus.

Care and Maintenance of the School Bus

The life a school bus and the dependable service that it can render depend on how the driver treats the bus. Daily inspection and expert handling will prolong the life of the bus and increase the quality of the service it gives.

While the driver should never attempt to make repairs himself, he must be constantly alert to the mechanical condition of the bus and should report any mechanical defect to the supervisor.

Each school system transportation supervisor is responsible for keeping every bus in his system in safe operating condition. This does not excuse the bus driver for operating a bus with a known mechanical defect. Drivers should respect the judgments and suggestions on care and maintenance of equipment given by mechanics.

Reporting Mechanical Defects

You should report needed repairs to the mechanic or supervisor as soon as possible. Most systems have a sign-in sheet on which needed repairs can be noted with less chance of them being overlooked. Do not be hesitant to report suspected problems.

Cleaning the Bus

You are responsible for keeping the school bus clean. A clean bus aids greatly in maintaining discipline and promotes a good image of school transportation in the community.

Keeping Records

Certain daily and monthly records and reports must be kept by you and submitted to the supervisor. The supervisor will advise you on methods of keeping and submitting records and reports. Some of these reports include pre-trip inspection, mileage, student counts, accurate student rosters, route maps, etc.

Responsibility for Safe Driving

A school bus is longer, wider, and heavier than a car. Driving it requires greater preparation, thought, and care.

The procedures set forth in this section are intended to promote the safety and comfort of school bus passengers and to ensure that they arrive at school each day ready to learn as much as they can.

On an activity bus, the passengers may take along baggage if it is secured and the driver and other occupants can move freely and easily. Riders must be able to use all exits and be protected from falling or shifting packages. No extra seats may be added to the bus. The aisle must be kept clear at all times.

*Riding in the bus with you
are several dozen children whose lives are in your
hands and who depend on your good judgment.*

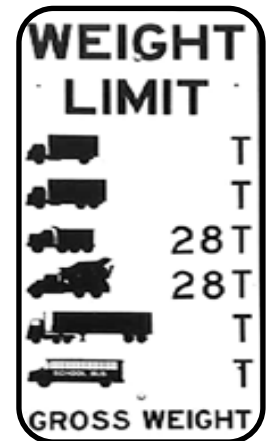
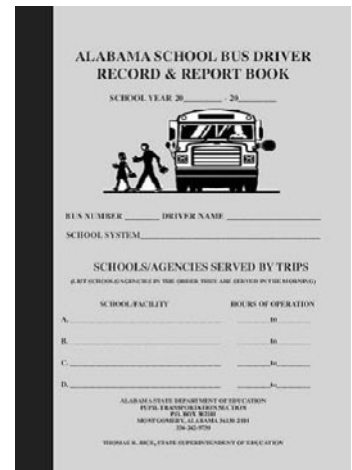

Vehicle Breakdown — Triangle Reflectors

If the school bus breaks down, the school bus driver should assess the situation and determine whether or not an emergency evacuation should be conducted (see Emergency Evacuation in Chapter 7). If possible, the school bus driver should get the bus off the roadway in a safe place and activate the hazard lights.

The driver should immediately contact the school bus shop to inform them of the exact location and the problem with the bus.

If triangle reflectors are to be placed, use the following diagrams:

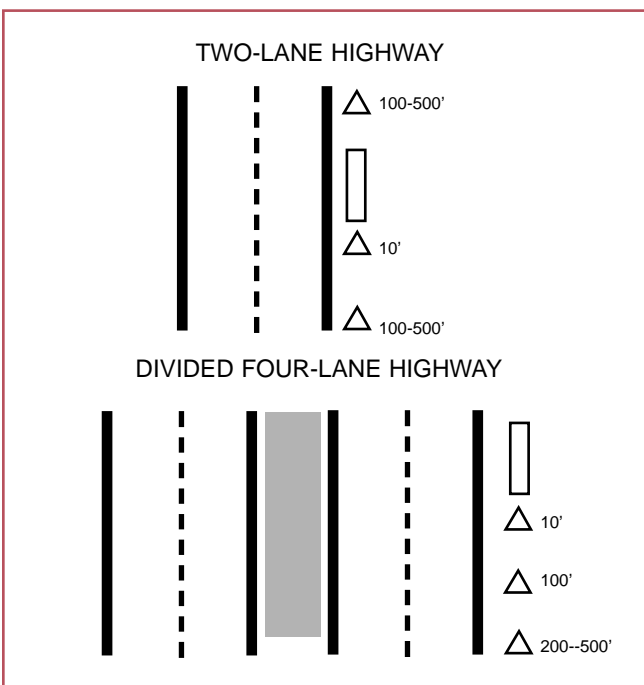

Vehicle Inspection: Why Inspect?

Safety

Safety is the most important and obvious reason for performing inspections. Inspecting your vehicle helps you to know your vehicle is safe.

Legal Requirements

Federal and state laws and school bus regulations require that school buses be inspected. A school bus also is subject to inspection by state and federal agencies. Alabama state law requires inspection of the bus by the driver, as well as a monthly inspection by certified mechanics at the local bus shop.

Types of Vehicle Inspection

Pre-Trip Inspection

You must perform a pre-trip inspection before each trip to find problems that could cause a crash, breakdown or other unsafe condition.

School bus drivers are legally required to document the pre-trip inspection before beginning the route/trip.

During a Trip

For safety sake you should:

1. Watch all gauges for signs of trouble.
2. Use your senses to check for problems (look, listen, smell, and feel).
3. Check critical items when you stop:
 - a. Brakes. ***This is the most important item to check in the pre-trip inspection.***
 - b. Lights.
 - c. Cargo securing devices (on activity trips).

Post-Trip Inspection and Report

You must perform a post-trip inspection at the end of each trip, day, and work shift. It may include filling out a vehicle condition report listing any problems you find. It includes checking the bus for students and locking the bus down. (Locking the bus down involves bleeding the air out of the air tank(s) until the spring brake applies and the air valve pops out.)

A 9-Step Inspection Method

Method of Inspecting

You should do a pre-trip inspection the same way each time so you learn all the steps and be less likely to forget something. The following 9-step procedure should be a useful guide. Having a routine procedure for inspecting the bus will eliminate the need to carry a pre-trip inspection checklist around with you as you inspect the bus. Documentation of the inspected items should be done upon the completion of the inspection. (Keep the inspection reports on the bus until you turn them in to the Transportation Office.)



Step 1 Vehicle Overview

Approaching the Vehicle. Notice general condition. Look for damage or the vehicle leaning to one side. Look under the vehicle for fresh oil, coolant, grease, or fuel leaks. Check the area around the vehicle for hazards to vehicle movement (people, animals, other vehicles, objects, low-hanging wires or limbs, etc.).

Step 2 Check the Engine Compartment

Check that the parking brake is on and/or the wheels are chocked. You will have to raise or tilt the hood, or open the engine compartment door to perform these checks.

Check the following:

- **Engine oil level.**
Above “add” mark.
- **Transmission fluid level.**
Above “add” mark.



- **Coolant level in radiator.**
Look at the sight glass or in the radiator itself; check condition of hoses. Never remove cap when engine is hot.



- **Windshield washer fluid.**

- **Power-steering fluid.** Above the “refill” mark. Check condition of hoses.

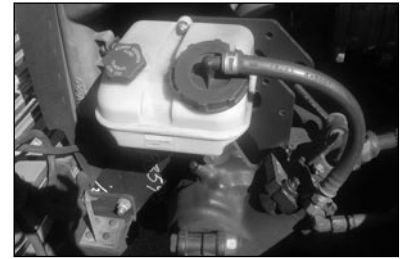

- **Belts.** Learn how much “give” the belts should have when adjusted correctly (no more than 3/4” of movement). Check each one.

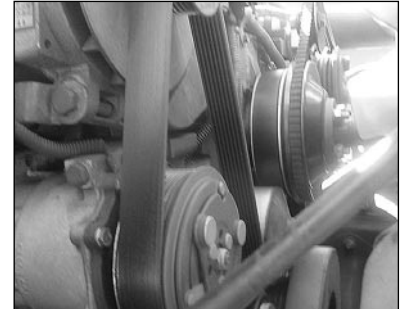

- **Steering box and steering linkage.** Driver should look for missing nuts, bolts, cotter keys, power steering fluid leaks, and damage to power steering hose. Connecting links, arms, rods from the box to the front wheels should not be worn or cracked.



- **Shock absorber.** Should be secure, unbroken, and have no leaks.

- **Spring mount and leaves.** Mount should be secure with no cracks or breaks, and no broken, missing or loose bolts. Bushings and axle mounting parts should not be damaged, broken, or missing. Check for missing or broken leaves; leaves that have shifted and may be nearly in contact with the tire, rim, brake drum, frame, or body. For a coil spring, look for breaks or distortions.

- **Brake chamber and hoses.** Should be securely mounted and not be cracked or dented. Hoses should not be cracked, worn, or frayed, and couplings should be secure.

- **Slack adjuster,** if equipped, should have no broken, loose, or missing parts. The angle between the push rod and the adjuster arm should be about 90 degrees when parking brake is released.



- **Brake drum.** Should have no cracks, dents, or holes and no missing or loose bolts. Brake linings should not be worn thin.



- **Wheels and rims.** Rims should not be damaged and have no welding repairs. Rust trails indicate that the rim is loose on the wheel. All lug nuts should be present and tight. There should be no cracks or distortion around the bolt holes. The hub oil seals, axle seals, and wheel bearing seals should not be leaking.



- **Tires.** Check for proper inflation. Check depth of tire grooves. Tread depth should not be less than 4/32" on front tires and 2/32" on the rear tires. No recaps may be used on the front. Recaps may be used on the rear. Tread must be evenly worn without cuts or other damage to the tread or walls. Valve caps and stems should not be missing or damaged. Retreads should not be separating from the tire.
- Lower and secure hood or engine compartment door.

Step 3 Front of Vehicle

Check the following items to see that nothing is wrong.



- **Passenger mirrors.** Should be secure, clean, and unbroken. **The passenger mirrors are likely the most important pieces of safety equipment on the bus and are absolutely necessary to operate it safely.** Children standing in front of the school bus may not be visible in any other way than by checking mirrors. Proper adjustment is essential to safety.



- **Lenses.** Clean and unbroken. None should be missing and they should be of the proper color.
- **Walking control arm.** Secure and not broken.

Step 4 Right Side of Vehicle

Check the following items:

- **Right side traffic mirror.** For security and cleanliness.
- **Passenger door.** For cleanliness and possible damage.
- **Reflectors and clearance lights.** Clean and unbroken.
- **Windows.** Clean and unbroken.

**Step
5**

Under the Vehicle and Right Side Rear

Check the following items:



- **Fuel tank.** Should be secure with no leaks or damage. Cap should be secure.

- **Suspension.** Condition of springs, spring mounts, shock absorbers, shackles, and U-bolts should be good.

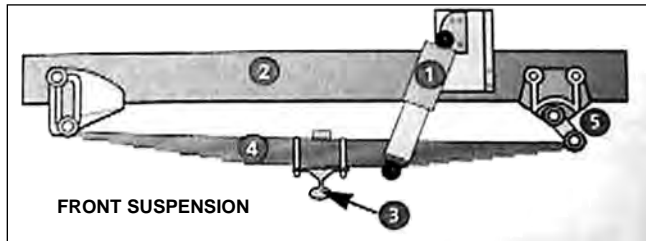

- | | |
|-----------------------------|-----------------|
| 1. Hydraulic Shock Absorber | 3. Front Axle |
| 2. Vehicle frame | 4. Leaf Spring |
| | 5. Spring Mount |

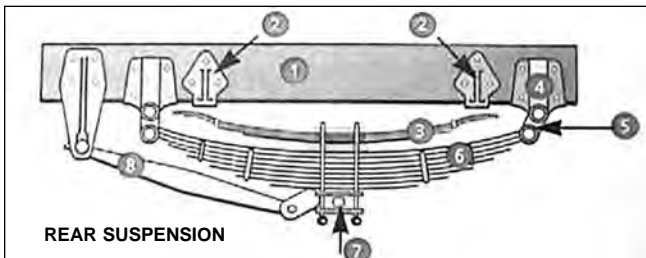

- | | |
|---------------------|----------------|
| 1. Frame | 5. Shackle |
| 2. Bearing Plates | 6. Main Spring |
| 3. Auxiliary Spring | 7. Axle |
| 4. Spring Hanger | 8. Torque Rod |

- **Brakes.** Drums, chambers, and slack adjusters should be in good condition. Hoses should not be worn.

- **Drive shaft.** Should not be bent or twisted. Universal joints should not be loose. Safety loops should be in place.

- **Frame.** No cracks or distortion should be evident in either the longitudinal or cross members.

- **Exhaust system.** Visible parts should be securely mounted without cracks, holes or severe dents. The muffler or pipes should not be touching wires, fuel hoses or air hoses.

- **Wheels and rims.** Rims should not be bent or damaged and should have no welding repairs. Rust trails may indicate that the rim is loose on wheel. All lug nuts should be present. There should be no cracks or distortion around the bolt holes. “Bud” or “Dish” wheels should have space between them and free of debris. The hub oil seals, axle seals and wheel bearing seals should not be leaking.



- **Tires.** Should be of same size, evenly matched and of the same type (radial or bias-ply). Tread depth, inflation, and wear should be normal.

**Step
6**

Rear



- **Lights and reflectors.** unbroken and/or proper color.
 - a. Reflectors. Red/Yellow.
 - b. Taillights. Red.
 - c. Turn signal lights. Red/Yellow.

- **Tailpipe.**

- **License plate.** Present, clean and secure.

- **Emergency door and holder.** Operational, clean, unbroken and seal intact.

**Step
7**

Left Rear and Left Side

- **All items as on right side.**

- **Stop-sign.** Flashing red lights clean, unbroken, and secure. (Light should flash alternately,)



- **Battery.** Securely mounted and wires attached.



Step 8

Passenger Entry

- **Door.** Operational, clean, and unbroken.

- **Stairwell.** Not bent, good tread, light working, and lens cover unbroken.



- **Handrail.** Present (required for a school bus), secure, undamaged, proper clearance.

- **First-aid kit.** Present (required for a school bus), secure, undamaged, and containing required items.



- **Body fluid clean-up kit.** Present, secure, undamaged, and containing required items.

- **Fire extinguisher.** Present (required for school bus), charged and of proper type (BC or ABC) for electrical and liquid-fuel fires. Ensure pin is in place. Remove extinguisher from its mounting bracket, shake it to mix chemical extinguish-ing agent.

- **Emergency reflectors.** Three present (required for school bus) and secure.

Step 9

Inside Checks

- **Check emergency exits and interior condition.**

1. Turn ignition key to “on.”
2. Turn on interior lights, if necessary, to see.
3. Check seats for vandalism, secure seat bottoms on way down aisle.

4. Open rear emergency door to see that warning buzzer and door are operational. Emergency door should always be secure when bus is moving and should not be blocked.



5. Check seats (secure to floor with no broken parts) on way back up the aisle.

6. Check emergency exit windows on sides and hatches in roof to see that they are operational and warning buzzer works.



7. Turn ignition key to “off.”

Note: On an activity bus the passengers may take along baggage if it is secured and the driver can move freely and easily. Riders must be able to use all exits and be protected from falling or shifting packages. No extra seats may be added. The aisle must remain clear at all times.

Schematic Diagram of Vehicle Equipment Check

Front:

- Crossing mirrors • Crossing arm • Windshield • Current inspection sticker
- Directional/Hazard signal lights • Top clearance lights • Headlights

Under the hood:

- Power steering level
- Belts (tension and condition)
- Air compressor
- Alternator
- Oil level
- Coolant level
- Transmission level
- Windshield washer fluid level

Steering

- Gearbox and linkage

On the driver's side:

- Stop sign
- Other items as on right
- Battery box

Engine start:

- Safety belt
- Air buzzer sounds
- Ammeter/voltmeter
- Air brake check
- Steering play
- Parking brake
- Mirrors
- Windshield/wipers/washer
- Lighting indicators
- Horn
- Heater/defroster
- Safety/emergency equipment
- Right passenger mirror
- Left passenger mirror



On the passenger's side:

Brakes

- Slack adjuster, air chamber, hoses, drums

Wheels

- Rims, hub oil seals, tires, lug nuts

Suspension

- Springs, spring mounts, shock absorbers

Driver/fuel area

- Door, mirror, fuel tank leaks

Under vehicle

- Drive shaft, exhaust system, frame

Suspension

- Spring, spring mounts, torsion/shocks

Wheels

- Rims, tires, axle seals, lug nuts, space between rear tires

Side

- Lights, reflectors

At the rear:

- Lights • Reflectors • Windows
- Lettering • Emergency door • Exhaust pipe
- Handicap decal (if special needs bus)
- Top strobe light

Adjustments in Preparing to Drive

- Set seat to comfortable position relative to steering wheel and pedals.
- Adjust all mirrors:
 - a. Traffic mirrors (right and left).
 - b. Inside rearview mirror.
 - c. Passenger (crossover) mirrors (right and left) to cover the areas in the front and to the sides of the bus. (nothing on dash)
- Fasten seat belt. The driver must wear the safety belt at all times while driving.

Start the Engine

- Listen for any unusual noises.
- Check the oil pressure gauge to see that it builds normally and no warning lights remain on. The gauge must come up to the first mark within a few seconds.



- Check the ammeter/voltmeter. The gauge will show that the battery is charging and there should not be any warning light on.
- Note temperature gauge. Should not register “hot.”
- Check fuel gauge. Should show enough fuel to complete trip and return to fueling point.

Check Condition of Controls

Check all of the following for proper functioning, cleanliness, looseness, sticking, damage and improper setting.



1. **Head lights** - Bright and dim. (Drive with headlights on day or night, rain or shine).
2. **Four-way flashers and indicators.**
3. **Horn** should be heard for at least 200 feet.
4. The **steering wheel** should have less than two inches (10%) of free play on a twenty inch wheel.
5. Stop sign should come out with lights and indicators flashing alternately.
6. **Yellow warning lights** should be operational when switch is engaged.
7. **Red flashing lights.** Should flash alternately in front and back. Should activate when door is cracked or opened and deactivate when door is closed. Walking control arm (if bus is so equipped) should swing out when stop sign comes out and swing in when the stop sign comes in.
8. **Interior lights.**
9. **Clearance lights.**
10. **Back-up lights.**
11. **Strobe light** (if bus is so equipped).



12. **Windshield and wipers** should be clean, clean, and free of cracks and illegal stickers. The rubber on the wipers should be solidly attached and should not be damaged or brittle. The wiper arms should have proper tension in the springs. Wiper and washer should work.
13. **Heater/defroster** should work on both high and low speed with all vents and air controls adjusted to heat the bus and clear the windshield.
14. **Gearshift.**
15. **Back-up Alarm.**

All warning buzzers and lights should be off before starting a trip.

Procedure for Brake Check

Air Brakes

1. Chock wheels.
2. Start the engine and build air pressure to 120 psi.
3. Turn the engine off, turn the ignition on and release Parking Brake (off-on-in).
4. To check for air leaks, watch air pressure to see that it does not lose more than 2 psi in one minute.
5. Place and hold foot on service brake. Watch air pressure gauge to see that it does not lose more than 3 psi in one minute.
6. To check the LOW AIR WARNING SYSTEM, pump the brakes down (deplete air from system) until the low air warning light and buzzer come on at approximately 60 psi.
7. Continue pumping down until the parking brake knob pops out at approximately 20 to 45 psi. This will indicate that the spring brakes have been applied. Remove chocks.
8. Start the engine. With the air pressure below 10 psi, place the transmission in gear and slightly press the accelerator to check the Emergency Brake System. Return transmission back into neutral. Once the air pressure is above 100 psi, place the transmission in gear again and slightly press the accelerator to check the Park Brake System. Then, check the service brake by releasing the Parking Brake and accelerate to approximately 5 mph. Apply pressure to service brake to ensure the bus does not pull side-to-side and stops smoothly.

EPS = emergency - parking - service

Hydraulic Brakes

- Pump the brake pedal three times.
- Apply firm pressure to the pedal and hold for five seconds.
- See that brake pedal does not move.
If it does, there may be a leak or other problem.
Get it fixed before driving.

If you find anything unsafe during the pre-trip inspection, get it fixed. Federal and state laws and school bus rules forbid operating an unsafe vehicle.

Post-Trip Inspection

Check the inside of the bus for passengers, books, clothing or materials which may have been left by students. If anything is found it should be stored until it can be returned.

1. Sweep the floor and steps of the bus.
2. Check the seats, window, and interior walls for damage or any markings and report or clean as may be necessary.

Faulty or improperly functioning equipment should be reported to the proper personnel.

Facilitate a clean bus attitude on the part of the students by enforcing clean bus rules and maintaining a clean bus. Periodically the bus interior and exterior should be washed, using soap and water. Using disinfectant on the interior occasionally is a good idea. This washing should include seats, windows, and windowsills.

Before leaving the bus always do the following:

1. Use the air brake valve to bleed the air from the system until the springs are activated if the bus is equipped with air brakes.
2. Walk the aisle to be certain there are no students left on the bus.
3. Generally, drivers should remove the key from the ignition. Check with your local supervisor.

Public Relations

The school bus driver accepts certain responsibilities to the community he/she serves in addition to his responsibility to the students who ride his/her bus. He/she should recognize that there is a very definite value in knowing the parents of the students who ride his/her bus. Parents are interested in their children and appreciate knowing the driver who is transporting them. Any interest displayed by the driver will cultivate respect for him on the part of the parents and will make the job of driving the school bus more enjoyable and successful.

Refer parents to the principal or supervisor for any request of change of stop, route, or schedule. Inform



them of any developments affecting the operation of the school bus, such as change of schedule and days when the bus may be late. An understanding between parents and the driver will develop close harmony and make it possible for the driver to perform his duties more efficiently and safely.

The driver's conduct, personal appearance, and appearance of the bus he drives leave an impression on parents, other motorists, and the general public. That impression should always be a good one.

Common Driving and Driver Abuses

The following list of common driving and driver abuses is put in this handbook for the driver to study. Improving driving and inspection habits will prolong the life of the bus, making it perform better, and be a safer vehicle for passengers to ride.

1. Engine Abuse:

- a. Engaging starter too long at one time.
- b. Excessive acceleration of cold engine.
- c. Operating overheated engine.
- d. Operating engine with low oil pressure.
- e. Racing engine.
- f. Failure to keep checking instrument panel gauges.

2. Lack of Maintenance Responsibility

- a. Driving bus even though it needs repairs.
- b. Failure to report defects and needed repairs.
- c. Failure to inspect equipment before each trip.

3. Errors in Use of Brakes

- a. Failure to use parking brake properly.
- b. Abrupt stops.
- c. Delayed braking.

4. Errors in Tire Care

- a. Operating with flat or under-inflated tires.
- b. Driving over curbs, objects and into potholes.
- c. Rubbing tires against curbs.

Test on Driver Responsibility

True or False

- | | |
|---|--|
| <p>_____ 1. The driver is considered a vital part of the overall educational team.</p> <p>_____ 2. The driver should not use tobacco while driving the bus.</p> <p>_____ 3. It is not the driver's responsibility to explain rules of conduct on the bus to students.</p> <p>_____ 4. Personal appearance and dress are not related to the driver's image.</p> <p>_____ 5. It is not necessary for the bus driver to be friendly when dealing with people.</p> <p>_____ 6. It is important that the driver exhibit emotional stability.</p> <p>_____ 7. The driver must be on time no matter what the cost.</p> <p>_____ 8. The driver should never share information about students with other school personnel even when the student's welfare is at stake.</p> <p>_____ 9. The driver should not try to become acquainted with parents unless it is absolutely necessary.</p> <p>_____ 10. It is important to race the motor when warming the engine.</p> <p>_____ 11. One of the most abusive driver habits is not reporting defects and needed repairs to mechanics.</p> <p>_____ 12. It is not necessary for the driver to make checks of the bus except when reports are due.</p> <p>_____ 13. Articles left on the bus should be ignored by the driver.</p> <p>_____ 14. One of the most important things a driver should do when conducting a post-trip inspection is ensuring no student is still on board the bus.</p> | <p>_____ 15. Alabama school bus drivers are only required to wear a properly fastened seat belt when students are being transported.</p> <p>_____ 16. You should not drive the bus if the oil pressure is low.</p> <p>_____ 17. The lives of school bus passengers are dependent upon the driver's knowledge, skills, judgments, and abilities.</p> <p>_____ 18. Having adequate driving skills is all that is required in order to become a totally competent school bus driver.</p> <p>_____ 19. The school bus driver should maintain pupil discipline by being firm, fair, and impartial.</p> <p>_____ 20. The school bus driver should stop at all designated bus stops, except when no children are visible.</p> <p>_____ 21. The school bus driver should learn to recognize some mechanical defects and report the symptoms to the proper authorities.</p> <p>_____ 22. The daily inspections of the bus will assist in preventing accidents and prolonging the life of the bus.</p> <p>_____ 23. When you have continuing problems with a disruptive student, you should talk to the coach.</p> <p>_____ 24. The driver can create a good image for the school system by driving a clean bus and being a careful and alert driver.</p> <p>_____ 25. When checking the oil level, the most accurate reading can be made after starting the engine.</p> |
|---|--|

School Bus Braking Systems

This section tells you about air brakes. You need this information for safe operation of air brakes on buses.

Two braking systems are commonly found on today's school buses. They are hydraulic brakes and air brakes. Both braking systems incorporate antilock brake systems (ABS). The most common braking system in use is the air brake system.

Most vehicles, including school buses, are coming out with ABS, otherwise known as anti-lock brakes. These facts will help acquaint you with anti-lock brakes. When the pedal is applied and the ABS is activated, the pedal may feel harder than usual. This is normal.

The pedal may seem to ratchet or pulsate (vibrate), or there could be a combination of these sensations. This is also normal. Finally, you may hear a noise that sounds like a motorboat engine. This is the hydraulic control unit operating — again normal.

Remember these important things when driving a vehicle with ABS brakes:

1. Maintain the same safe stopping distance from the vehicle ahead as with conventional brakes. ABS will not make the vehicle “stop on a dime.”
2. When emergency braking is necessary, do not pump the brake. Just apply firm, constant pressure and let ABS do the work. You may feel a slight vibration or hear noise as the hydraulic control unit functions. Continue to push the pedal further if it travels closer to the floor.
3. Remember, if the ABS light comes on while you are driving, you still have air brakes.

Air brakes use compressed air to operate. You can apply all the braking force you need to each of the wheels of a heavy vehicle. Air brakes are a safe way of stopping large vehicles if the brakes are well maintained and used correctly.

However, you must know more about air brakes than you need to know with the simpler hydraulic brake systems used on many buses and on light vehicles.

Air brake systems consist of three braking systems combined: the service brake system, the parking brake system, and the emergency brake system.

The service brake system applies and releases the brakes when you use the brake pedal during normal driving.

The parking brake system applies and releases the parking brakes when you use the parking brake control.

The emergency brake system uses parts of the service and the parking brake systems to stop the vehicle in the event of a brake system failure.

Parts of an Air Brake System

There are many parts to an air brake system. You should know about the parts discussed here.

Air Compressor

The air compressor pumps air into the air storage tanks (reservoirs). The air compressor is connected to the engine through gears or a V-belt.

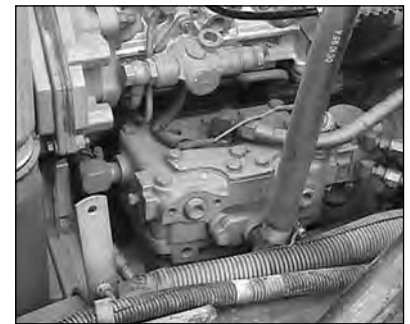

Air Compressor Governor

The governor controls when the air compressor will pump air into the air storage tanks. When air tank pressure rises to the “cut-out” level (around 120 pounds per square inch, or “psi”), the governor stops the compressor from pumping air. When the tank pressure falls to the “cut-in” pressure (around 100 psi), the governor allows the compressor to start pumping again.

Air Pressure Gauge (Supply Pressure Gauge)

All air brake-equipped vehicles must have a pressure gauge connected to the air tank. The air pressure gauge on the bus gives a reading in pounds per square inch (psi). The reading on the gauge should be approximately 100-120 pounds per square inch. If the air pressure falls below this level (at about 100 psi), the air compressor will begin pumping again. If the vehicle has a dual air brake system, there will be a gauge for each half of the system (or a single gauge with two needles). These gauges indicate how much pressure is in the air tanks.



Air Storage Tanks

Air storage tanks are used to hold compressed air. The number and size of air tanks varies among vehicles. The tanks will hold enough air to allow the brakes to be used several times even if the compressor stops working.

Remember that the number, size, location, and appearance of air storage tanks will vary from bus to bus.

Safety Valve

The first tank receiving compressed air is equipped with a safety valve. The safety valve protects the tank and the rest of the system from too much pressure. The valve is usually set to open at 150 psi. If the safety valve releases air, something is wrong. Have the fault fixed by a mechanic.

Air Chamber

Air chambers are located at each of the four wheel positions of the bus.

Air from the storage tanks enters these chambers when you press the brake pedal. A special mechanism causes the brakes to lock up when there is an insufficient amount of air pressure.



Slack Adjusters

Over time a certain amount of wear will occur in any brake system. The slack adjusters at each wheel are designed to balance this wear.



Brake Drums, Shoes, and Linings

Brake drums are located on each end of the vehicle's axles. The wheels are bolted to the drums. The braking mechanism is inside the drum. To stop, the brake shoes and linings are pushed against the inside of the drum. This causes friction that slows the vehicle (and creates heat). The heat a drum can take without damage depends on how hard and how long the brakes are used. Too much heat can make the brakes stop working. On school buses, the brake linings are not visible and the driver is not required to check them.

The Brake Pedal

You apply the brakes by pushing down the brake pedal. Pushing the pedal down harder applies more air pressure. Letting up on the brake pedal reduces the air pressure and releases the brakes. Releasing the brakes lets some compressed air go out of the system, so the air pressure in the tanks is reduced. It must be made up by the air compressor. Pressing and releasing the pedal unnecessarily can let air out faster than the compressor can replace it. If the pressure gets too low the brakes will not work and the emergency brake system will be activated.

When you push the brake pedal down, two forces push back against your foot. One force comes from a spring. The second force comes from the air pressure going to the brakes. This lets you feel how much air pressure is being applied to the brakes.

Foundation brakes are used at each wheel. The most common type is the drum brake.

Stop-Light Switch

Drivers behind the bus must be warned when you put your brakes on. The air brake system does this with an electric switch that works by air pressure. The switch turns on the brake lights when you put on the air brakes.

Emergency and Parking Brakes

All air brake buses must be equipped with emergency brakes and parking brakes. They must be held on by mechanical force (because air pressure can eventually leak away). Very strong springs are used to meet these needs. When driving, powerful springs are held back by air pressure. If the air pressure is removed, the springs put on the brakes. A parking brake control in the bus allows the driver to release air from the air brake system. By releasing the air, the springs are activated. A leak in the air brake system that causes all the air to be lost also will activate the spring brakes.

The springs should activate when air pressure drops to a range of 20 to 45 psi. Do not wait for the brakes to come on automatically. When the low air pressure warning light and buzzer first come on, bring the vehicle to a safe stop right away, while you can still control the brakes.

The braking power of the springs depends on the brakes being in adjustment. If the brakes are not adjusted properly, neither the regular nor the emergency brakes will work right. Failure of the air brake system is most often caused by brakes that are out of adjustment.

Parking Brake Controls

The parking brake is controlled by a yellow push-pull control knob. Pull the knob out to engage the parking (spring brakes), and push it in to release them. Use the parking brakes whenever you park the bus.

Whenever you suspect something is wrong with the braking system, it should be reported to the bus shop immediately.

Dual Air Brake Systems

All buses use dual air brake systems for safety. A dual air brake system has two separate air brake systems that use a single set of brake controls. Each system has its own air tanks, hoses, lines, etc. One system typically operates the regular brakes on the rear axle. The other system operates

the regular brakes on the front axle. The first system is called the “primary” system. The other is called the “secondary” system.

Before driving a vehicle with a dual air system, allow time for the air compressor to build up to a minimum of 100 psi pressure in both the primary and the secondary systems. Watch the primary and secondary air pressure gauge needles (some systems have one gauge with two needles). Pay attention to the low air pressure warning light and buzzer. The warning light and buzzer should shut off when the air pressure in both systems rises to a value set by the manufacturer. This value must be greater than 60 psi.

Low Air Pressure Warning

The warning light and buzzer should come on before the air pressure drops below 60 psi in either system. If this happens while driving, you should stop right away and safely park the vehicle. If one air system is very low on pressure, either the front or the rear brakes will not be operating fully. This means it will take you longer to stop the bus. Bring the vehicle to a safe stop and have the air brake system repaired.



Check Air Compressor Cut-In and Cut-Out Pressures

Pumping by the air compressor should start at about 100 psi and stop about 120 psi. Run the engine at a fast idle, but do not exceed 1500 rpm.

The air compressor governor should cut-out the air compressor about 120 psi. The air pressure shown by the gauge(s) will stop rising. With the engine idling, step on and off the brake pedal to reduce the air tank pressure. The compressor should cut-in at about 100 psi. The air pressure should begin to rise. If the air governor does not work as described above, it should be repaired. A governor that does not work properly may not keep enough air pressure for safe driving.

Whenever you suspect something is wrong with the braking system, you should perform an emergency stop and contact the transportation department and stop the bus immediately.

Using Air Brakes

Normal Stops

Push the brake pedal down. Control the pressure so the vehicle comes to a smooth, safe stop.

Emergency Stops

Braking should allow for steering the bus in a straight line. Use one of the following two methods:

Controlled Braking

This method is also called “squeeze” braking. Put on the brakes as hard as you can without locking the wheels. Do not turn the steering wheel while doing this. If you need to make large steering adjustments or if you feel the wheels beginning to slide, release the brakes. Brake again as soon as the tires regain traction.

Stab Braking

Should the anti-locking braking system fail:

- a. Press on the brake pedal as hard as you can.
- b. Release the brakes when the wheels lock up.
- c. As soon as the wheels start rolling, put on the brakes fully again.

It can take up to one second for the wheels to start rolling after you release the brakes. Make sure you stay off the brakes. Do not apply the brakes until the wheels start rolling again; otherwise, the vehicle may not stay in a straight line. You lose steering control when your front tires are not rolling. If the bus is equipped with ABS, **DO NOT USE** stab braking.

Braking on Downgrades

On downgrades, brakes fail due to overheating. The right way to use the brakes for long downhill grades is to go slowly enough that a sparing use of the brakes will keep the speed from increasing. If the speed is appropriate, the brakes will be able to get rid of the heat and they will not get too hot.

Firm, intermittent braking (snubbing) is safer than light, continued braking. Letting up on the brakes from time to time will allow them to cool enough so that they do not become overheated. Tests have proven this to be true. Light, continued pressure causes hot-spotting and in general makes the brakes run hotter, leading to increased probability of brake fade. Therefore, select the right gear, go slow enough, and use firm, intermittent braking (snubbing).

Low Air Pressure Warning

If the low air pressure warning signal comes on, stop and safely park the bus as soon as possible. There might be an air leak in the system. Controlled braking is possible only while enough air remains in the air tanks. It is much safer to stop while there is enough air in the tanks to use the foot brake.

Parking Brakes

Any time you park the bus for a short period of time, use the parking brake. Pull the parking brake control knob out to apply the parking brakes; push it in to release them. The control will be a yellow, diamond-shaped knob labeled “parking brake” on newer vehicles.

When parking the bus for a long period of time, decrease the air pressure to below 30 psi. This will activate the emergency system and will prevent the bus from being moved unless the engine is started, and the pressure is built back up. To decrease the air pressure, the parking brake knob should be pushed halfway in to bleed the air down until the parking brake knob will not stay in.

Drive safely!

Your passengers are depending on you!

Test on Air Brakes

Short Answer

1. Why is it important to “lock down” the bus after completion of a route or trip?
2. What happens when the air pressure falls below approximately 60 psi?
3. What should happen when the air pressure falls between 20/45 psi?

Multiple Choice

4. At what psi should the air compressor governor cut in and out?
 - a. In at 100 and out at 120
 - b. In at 60 and out at 90
 - c. In at 20 and out at 60
 - d. None of the above
5. If the yellow ABS light activates, what should you do?
 - a. Stop the bus immediately and call for help.
 - b. Continue driving and contact the bus shop as soon as your trip is complete.
 - c. Check the fuses to ensure none have blown.
 - d. Ignore the warning, it will correct itself.
6. The type of braking used on a steep downhill incline should be:
 - a. squeeze
 - b. stab
 - c. snubbing
 - d. normal
7. How does a bus driver check the parking brake on a air brake system?
 - a. Release parking brake and move bus forward.
 - b. Apply parking brake and gently pull against it.
 - c. Apply the parking brake and accelerate hard.
 - d. The parking brake can be checked only by a certified mechanic.
8. While driving the bus, the red low air pressure warning is activated. What should a driver do?
 - a. Drive to the nearest garage.
 - b. Safely stop the bus as soon as possible.
 - c. If only the light comes on, continue on the trip or route.
 - d. Drive at a faster rate of speed to make the air compressor pump faster and build the air back up.
9. What is a PSI gauge used for?
 - a. Lets you know how much pressure is applied to the service brake.
 - b. Lets you know the amount of air available in the air tanks.
 - c. Tells you how much brake fluid is present in the brake fluid reservoir.
 - d. Keeps the air compressor from pumping too much air.

True or False

10. All vehicles with air brakes must have a low air warning signal.
11. When the air pressure drops to approximately 45 psi or below, the springs should activate.
12. A safety relief valve releases air when the pressure in the air tank reaches 150 psi.
13. Firm, intermittent braking on a steep downgrade is the process of applying pressure on the brakes and releasing repeatedly to keep the brakes from overheating.
14. When emergency braking on a vehicle with anti-lock brakes is necessary, pump the brakes hard to stop faster.

Fundamentals of Driving a School Bus

Driving Procedure

The purpose of this chapter is to teach you the basic skills you will need to operate a school bus safely and efficiently. In order for you to become a safe and efficient driver, you will need to practice good driving habits constantly. Time behind the wheel of a school bus is not enough to make you a safe driver. The time must be spent wisely in developing good driving habits and eliminating bad ones.

The driving skills that you use to operate an automobile are similar to the skills you need to operate a school bus. However, there are some very important differences. For example, a school bus is longer and heavier, higher, and wider (more clearance required), has slower acceleration and longer stopping distance, takes more room to turn, and the bus driver must rely more heavily on mirrors for an adequate rear and side view.

The procedure used in starting a bus should be practiced until it becomes routine. The seatbelt should be adjusted so that you are able to operate the bus comfortably. Check the mirrors to see that they are adjusted properly for your height and position. The bus driver should be able to see where the rear wheels of the bus strike the ground as well as the ground in front of the bus. This will aid in turning, backing, lane position, lane change, and other maneuvers. More importantly, it will assist the driver during the loading/unloading process to see students and other persons or objects that may be along side or in front of the bus. The driver must fasten the seatbelt properly and ensure that passengers also buckle their seat belts where they are provided.

Before driving a different school bus the driver should understand the purpose and correct reading for each gauge and know the location of each switch. The position of various gauges and switches will vary depending on the type of bus.



Starting the Engine

There are many different kinds and models of engines in Alabama school buses. Exact procedures for starting each of them will be taught as needed in the practice phase of the training. However, several general procedures are used for all:

1. Check the parking brake and fasten the seat belt.
2. Make sure the bus is in neutral. (Automatic transmissions buses will not crank while in gear.)
3. Start the engine.
4. Allow the engine to warm up for a sufficient amount of time to ensure smooth operation. Do not race the engine during the warm-up period, as this will cause severe damage to the engine.

Starting, Steering and Stopping

Smoothness in driving is one key to both safe driving and good relations with passengers. To keep from rolling backward on hills on a bus equipped with an automatic transmission, use the parking brake to hold the bus in position while depressing the accelerator with the right foot. When the bus begins to pull forward against the parking brake, release the parking brake and the bus will move forward without rolling back. This technique should be repeated several times during the practice phase of your training.

Steer smoothly, hand over hand, using two hands in steering at all times. Your hands should be at the ten and two or nine and three o'clock positions on the steering wheel. (One hand on the wheel is less than half as safe.) If the driver has to steer quickly or jerkily, he was going too fast for the maneuver.

Use the right foot for all normal braking. A school bus is much heavier than smaller vehicles and requires the driver to begin braking sooner in order to stop smoothly. Feather the brake by slackening pressure on the brake pedal slightly just before the wheels stop rolling. This creates a smoother stop and happier passengers. A good driver anticipates stops as much as possible. This increases the margin of safety and helps save brake shoes. Avoid sudden stops.

Following Distances for School Buses

Safety demands that the driver maintain sufficient distance between the bus and the vehicle ahead under any conditions. It is



important to estimate this following distance accurately. Constant practice in estimating distances will keep the driver prepared for any problem. On the open highway, the basic following distance rule, under good weather conditions, is to stay four seconds behind the vehicle ahead while traveling at forty miles per hour or less. If traveling over forty miles per hour, add an additional second for a total of five seconds. As the weather worsens, following distance should increase to allow more space to stop.

Following too closely is one of the most common causes of accidents, even among school bus drivers!

Stopping Distance

There are three things that add up to total stopping distance:

$$\begin{array}{r}
 \text{Perception Distance} \\
 \text{Reaction Distance} \\
 + \text{Braking Distance} \\
 \hline
 = \text{Total Stopping Distance}
 \end{array}$$

Add 3/4 second for lag time if the bus is equipped with air brakes.

Perception Distance

Perception distance is the distance your vehicle travels from the time your eyes see a hazard until your brain

recognizes it. The perception time for an alert driver is about 3/4 of a second. At 55 mph, you travel about 60 feet in 3/4 of a second.

Reaction Distance

Reaction distance is the distance your vehicle travels from the time your brain tells your foot to move from the accelerator until your foot is actually pushing the brake pedal. The average driver has a reaction time of 3/4 second. This accounts for an additional 60 feet traveled at 55 mph.

Lag Time

On a bus equipped with air brakes, an additional 3/4 second brake lag occurs during which the bus is still moving.

Braking Distance

Braking distance is the distance it takes to stop once the brakes are applied. At 55 mph, it can take a heavy vehicle, like a school bus, about 275 feet to stop. It takes about 4 1/2 seconds.



Total Stopping Distance

At 55 mph, your vehicle will travel about the distance of a football field in coming to a smooth, safe stop.
 $(60 + 60 + 275 = 395)$

The Effect of Speed on Stopping Distance

Whenever you double your speed, it takes about four times the distance to stop, and the vehicle will have four times the destructive power if it crashes. High speeds increase stopping distance greatly. By slowing down a little, you can gain a lot in reduced braking distance. Additionally, tire traction decreases as speed increases. Therefore, it is our recommendation for school bus drivers to travel at least 5 mph below the posted speed limit.

The Effect of Vehicle Weight on Stopping Distance

The heavier the vehicle, the more work the brakes must do to stop it and the more heat they absorb. But the brakes, tires, springs, and shock absorbers on heavy vehicles are designed to work best when the vehicle is fully loaded. Empty trucks require greater stopping distances, because an empty vehicle has less traction. It can bounce and lock up its wheels, giving much poorer braking. This is usually not the case with buses.

Right of Way



There are two kinds of intersections: regulated and unregulated. Unregulated intersections are those with no signal lights or signs. When approaching an unregulated intersection, reduce speed, check traffic to see that the intersection is clear, and only then proceed. If another vehicle is already in or very near the intersection, you should yield right of way to that other vehicle; if two vehicles arrive at the same time, the vehicle on the left yields to the vehicle on the right. **The law always states that a certain vehicle shall yield; it never states that a vehicle has the right of way.** The purpose of these right-of-way laws is to prevent accidents by prescribing who shall go last.

Under normal circumstances, the ALSDE recommends that school bus drivers treat YIELD signs as STOP signs. There may be exceptions to this recommendation, but drivers should consult with their local supervisor.

Curves

The proper procedure for rounding a curve is to decelerate and look ahead for the sharpest point in the curve, then brake, if necessary, before entering the curve. At the midpoint of the curve, resume power and accelerate slightly through the remainder of the curve.

Intersections

More accidents occur at intersections than any other location on the road because they are the most confusing places on the highway. Other drivers do unexpected things at intersections, and it is important that you be alert to these drivers and prepare for any problem when approaching and entering every intersection.

Expect the Unexpected!!!

Many accidents occur as a result of making improper turns at intersections. Numerous errors, such as approaching too fast, turning too soon and hitting an object to the right or the left, turning into the wrong lane, failure to yield the right-of-way and many others, can be eliminated by executing each turn in a careful and deliberate manner with careful attention to well-adjusted mirrors.

Changing Lanes

Driving a school bus in urban areas means having to change lanes more frequently. In a school bus, this requires greater concentration and more careful use of mirrors than in a car. To change lanes, the bus driver should signal early, check mirrors and blind spots and move in to the proper lane gradually. Once positioned in the new lane, make sure the turn signal is canceled.

Procedure for Making Turns

1. Get into the proper lane well in advance of the turn.
2. Check traffic conditions to the front, rear and sides.
3. Engage the turn signal at least 100 feet in advance of the turn.
4. Brake gradually to a safe speed, usually 10 miles per hour or less, at least 50 feet before the turn.
5. Check traffic again to the front, rear and sides.
6. Check clearance while turning into the correct lane. (Always turn in the lane closest to you.)
7. Complete the turn, using both hands on the wheel (hand-over-hand steering).
8. Straighten the bus; cancel the turn signal.



Lane selection for turning is as follows:

Left from a two-way roadway onto a two-way roadway having either two, four, or six lanes.

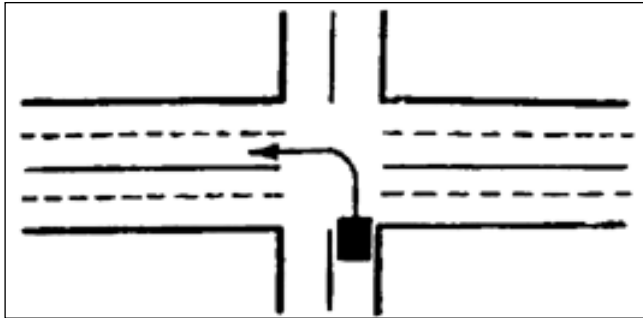

Left turn from a two-way onto a one-way roadway.

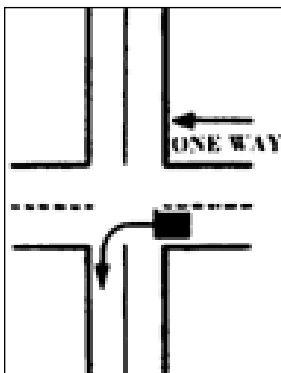
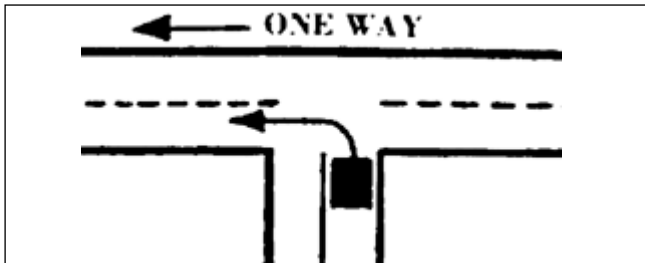

Left from a one way roadway onto a two-way roadway.

Left from four-lane to four-lane.

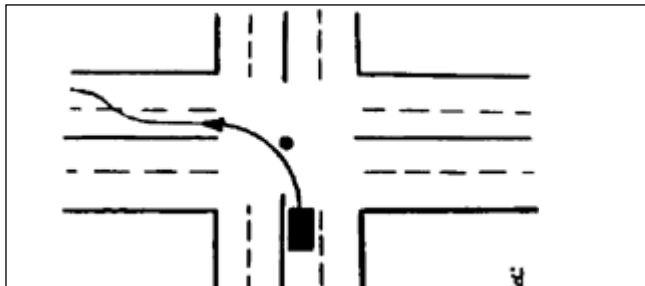

Good Rule: Never make a lane change when turning, if possible.

As a general rule, the ALSDE recommends that school buses do not turn right on red. Any exceptions to this rule should be discussed/authorized by the local supervisor.

Right turn from any type roadway onto any type roadway (one way).

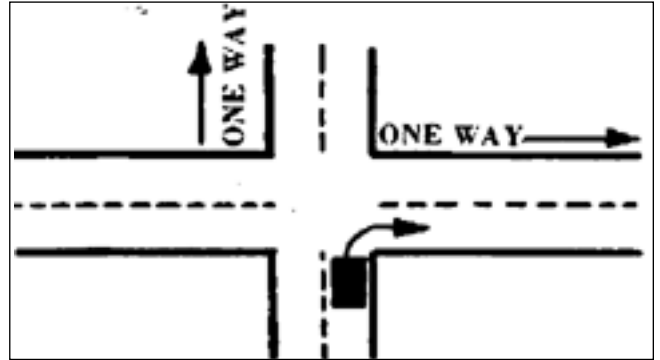

Left from one-way roadway onto a one-way roadway. Vehicle must approach for the turn and make the turn, as close as practicable, to the left-hand curb or edge of the roadway.

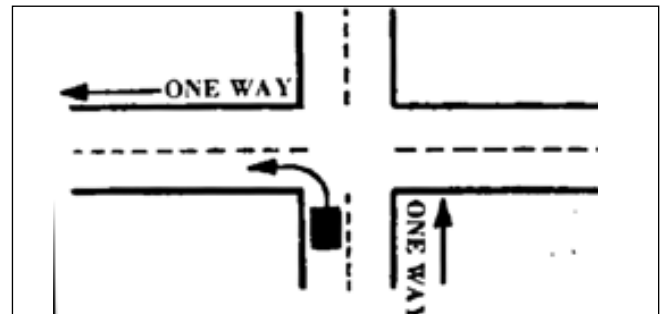

Left from a three-lane, two-way roadway onto a two-lane, two-way roadway.

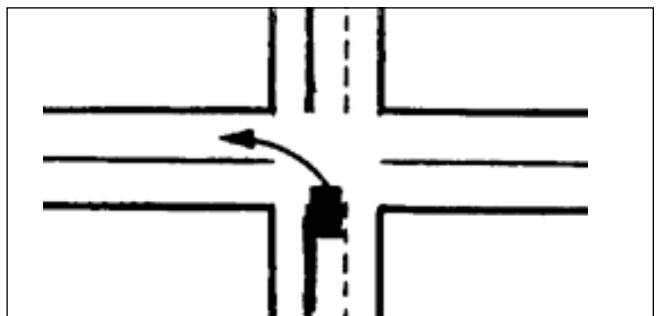

When turning right, a school bus may have trouble clearing the curb. The driver should remember that responsibility for making a safe turn rests with the bus driver. He/she should approach the corner in the right-hand lane about four feet from the curb. The bus should not be far enough away from the curb to allow a vehicle between the bus and the curb. As soon as the front wheels pass the corner, turn wide to the right, swinging over the center of the side street, if necessary, in order for the right rear wheels to clear the curb. Check the side mirrors while executing the turn.

Railroad Crossings

The most tragic school bus accidents that have ever happened have taken place at railroad crossings.

The results are usually multiple fatalities. School bus regulations require that buses stop at all railroad crossings. The front bumper should be no closer than fifteen (15) feet from the nearest track and no farther away than fifty (50) feet. Visibility is the determining factor. Fifteen (15) feet can be estimated by being able to see the nearest rail over the hood of the bus.

Safety Procedures at Railroad Crossings

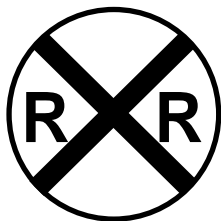

1. Check traffic and activate hazard lights approximately 500 feet from the crossing.
 2. Open the window.
 3. Shut down all noise heater/defroster, radios, students, etc. (not the engine).
 4. Stop no closer than 15 feet nor farther away than 50 feet from the nearest rail.
- 
5. Immediately apply the parking brake.
 6. Open the door **when safe**.
 7. Look and listen for the train.
 8. If a train is seen or heard approaching, close the door and wait for the train to pass. After the train passes, open the door and check for another train then proceed with caution when clear.
 9. If no train is present, close the door, release the parking brake, and proceed with caution only after you have determined that no train is approaching. Continue to check both directions while crossing the tracks.
 10. Deactivate the hazard lights and resume normal operations after crossing the tracks.

If there is more than one set of tracks, be certain that all tracks are clear before proceeding. Do not assume that just because one train has passed another is not approaching from the same or a different direction.

If the lights are activated and/or the crossing gate is down, **DO NOT CROSS** the tracks even if you think they are malfunctioning. Contact your supervisor/dispatch/transportation department to report the signal problem and to seek advice. Cross only if a railroad flagman or police officer gives you permission. You do not have to stop at a track that is posted "EXEMPT"

If the bus stalls on a railroad crossing, evacuate the bus immediately! If a train is approaching, the passengers

should move away from the bus in the direction of the train at a 45 degree angle from the track. If the train hits the bus, pieces of the bus will be less likely to hit any of the



students. After the students are safely evacuated, the driver may return to the bus and try to start the engine while monitors watch and listen for an approaching train.

Always be certain that the bus can safely clear all tracks and any area beyond the tracks in which the bus will not fit. Examples of this could include:

- Tracks close to intersections
- Multiple tracks
- Tracks around warehouses or storage areas
- Railroad car switching areas

Loading and Unloading

The most dangerous part of the bus trip for students is when they are loading or unloading the bus. When students are outside the bus, the chances of them being injured or killed is much greater than when they are on the bus. The route that your school bus travels and the exact location of each stop are the responsibility of the local

TRAINS ALWAYS HAVE THE RIGHT OF WAY!!!

board of education and the transportation supervisor. They rely on you, the bus driver, to inform them of any dangerous situations encountered on the route, especially in regard to passenger stops.



There are several things you should keep in mind in making stops:

Make sure that all your stops are made in a safe place.

Ideally, visibility should be at least 500 feet in both directions.



If a stop must be made in a curve or on a hill, it should be made in the middle of the curve or on top of the hill.

The bus should be positioned on the right lane portion of the highway. When possible, it is preferred that students are loaded/unloaded on door side (especially with multiple lanes of traffic). **Students who must cross the road should do so under the watchful eye of the school bus driver and the protection of the school bus warning system (students should never cross a divided roadway, see p.3 for reference).**

The driver is the most important safety component in the loading/unloading process. The yellow warning lights should be activated approximately 300 feet before reaching the designated stop.

In the morning, students should wait safely off the roadway until the bus has stopped, traffic has stopped, the door is open, and the driver signals them to load.

If it is necessary for students to cross the road to load or unload, they should cross at a point 12 feet in front of the bus, **NEVER BEHIND THE BUS!**

Stops should be made no less than 10 feet from the nearest passengers. Do not position the door even with the passengers; one of them might fall or be pushed in front of the bus.

The bus should not be moved or traffic released until all students have reached a point of safety on the side of the road on which they live or have boarded the school bus.

After the bus has completely stopped to load or unload passengers, you should **immediately** activate the red flashing lights and the stop sign. **Engage the parking brake and check traffic to determine when it is safe for students to be loaded or unloaded. You, the bus driver, must account for all students.**

When students are safely loaded/unloaded, check traffic, release parking brake, and deactivate the red flashing light and stop sign.

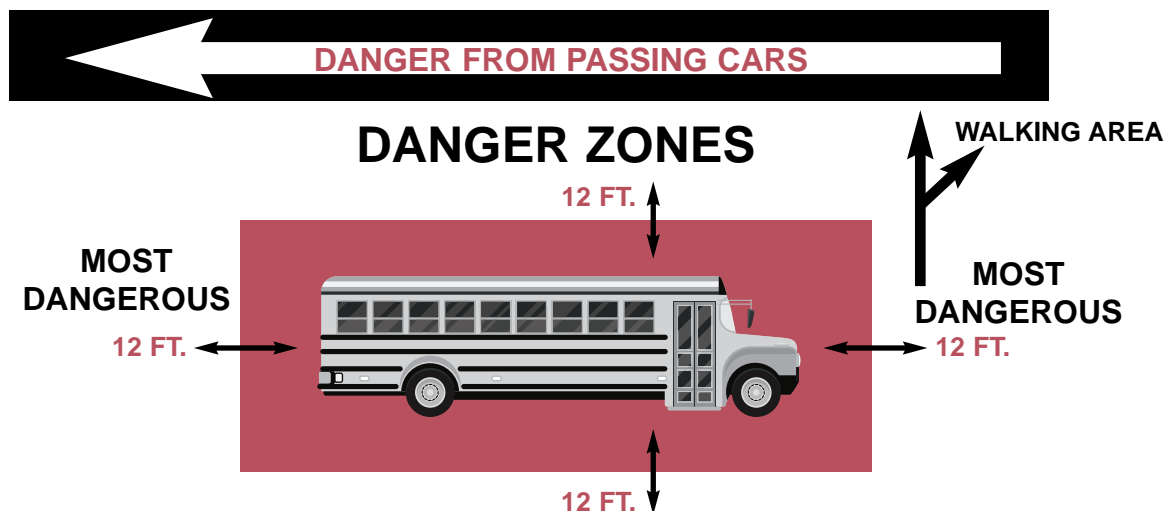



A safe loading or unloading requires several checks of the mirrors before releasing traffic or moving the bus. This will ensure that all traffic has stopped and that no students or anything else remains in the danger zones around the bus.

Drivers should watch students unloading to ensure that no articles of clothing, equipment, or other items become caught on the handrail, door handle, or other parts of the bus.

School bus stops should not be located at street intersections, near railroad tracks, or too close together. It is recommended that school bus stops be at least .2 of mile apart.



There are many dangerous situations that can develop on the school campus. **No bus should ever break the loading or unloading “line-up” by pulling around another bus or buses ahead. No bus should ever be driven backwards on the school grounds** where children are being loaded or unloaded or where there is any possibility of students being in the vicinity of the bus.

It is recommended that the warning system always be used when loading or unloading students. Under certain restricted situations, school bus drivers may be asked not to use this system. All such situations should be approved by the transportation supervisor and the principal of the school or other authorized person. (refer to p. 5)

Drivers and anyone else involved in the loading or unloading of students must understand that **students feel safe around the school bus** whether on campus or on the highways. They often do not pay as much attention to

traffic and other dangers as they should. This increases the responsibility of the driver and others in ensuring the safety of the students.

*Don't take chances!
Follow proper safety procedures!*

Student Loading/Unloading Procedures (Automatic Transmission*)

1. Check traffic, weather and road conditions to determine a safe distance needed to warn traffic of an upcoming stop.
2. Activate yellow warning lights a safe distance (at least 300 feet in rural areas and 100 feet in urban areas).
3. Stop 10-15 feet before loading or unloading area:
 - a. Activate red flashing lights and stop sign.
 - b. Apply parking brake and check traffic.
 - c. Open door when safe.
4. Students should load in an orderly fashion after the bus stops, all traffic stops and the bus driver signals them to load.
5. Students should be seated before the bus moves.
6. Before moving the bus, the driver must:
 - a. Close door.
 - b. Release parking brake and check all mirrors, especially front crossover and side mirrors.
 - c. Deactivate red flashing lights and stop sign.
7. During the loading and unloading process, the driver should **COUNT** the students and move the bus **ONLY** after **ALL** students are safely on the side of the road on which they live or in their seats. Be alert for students' apparel or carry-on items being caught on the bus handrail, door, door handle, etc.
8. All students who live on the left side of the road should exit first and cross in single file.

IMITATION RULE

- * **Except for specific situations defined in AL CODE 32 (ACT #2006-311), when your bus is approaching or following another bus that is loading or unloading, you should mirror the other bus' procedures. If there is any traffic between you and the other bus, use hazard lights only.**
- * **Be alert for student apparel and book bags being caught on the bus handrail, door, door handle, etc.**
- * **Never move the bus with the door open or cracked.**

Backing the Bus

Even under the most favorable conditions, backing the school bus is an extremely dangerous maneuver. The bus can be difficult to control and the driver's vision to the rear is seriously limited. When a driver thinks of backing, he should automatically think of **danger**. School bus drivers should never back a bus unless absolutely necessary.

Accident reports show that backing is one of the most dangerous maneuvers a driver can perform. You should never back a bus from a side road into a main road. This is against the law. If a turn-around is required on the route, students should be loaded before the backing is done or unloaded afterwards.

Students are generally safer on the bus during the backing maneuver. Any time backing is absolutely necessary:

- 1. Get a helper when you can.**
- 2. Activate the hazard lights.**
- 3. Blow the horn several times.**
- 4. Reduce noise on bus**
- 5. Back slowly.**
- 6. Use your mirrors.**

Always check the area into which you are backing with your naked eye before starting to back.

Take pull-ups to help improve the view of this area.
It is always better to take a pull-up than to hit anything. Do not continue to back when you cannot see what you think you should.

Mirrored vision is reduced vision.

Pavement Markings

Generally, there are four types of pavement markings: centerline striping, edge striping, crosswalks and stop-lines, and pavement messages.

Centerline Striping

The centerline is the painted stripe in the center of a road which separates the traffic proceeding in opposite directions. Under the Uniform Code, centerlines are to be painted yellow on two lane highways and white on multi-lane highways and one-way streets. Dashed lines are used in areas where there are no restrictions on passing when it

is safe to do so. In those areas where passing is not allowed, a solid yellow line is found on your side of the centerline; you may not pass. If passing is not allowed for traffic in both directions, the dashed yellow line will be replaced by two solid yellow lines.

Do not pass unless absolutely necessary!

Lane dividers

When a roadway consists of two or more traffic lanes for vehicles moving in one direction, the lanes are divided by dashed white lines. These dashed lines may be crossed when passing.

Edge Striping

In many areas, the right and/or left edges of the highway are marked with a solid white line. This line indicates the outside edge of the traffic lane, and may be crossed only by traffic moving to or from the shoulder. Occasionally, yellow lines are used for left edge lines on divided roadway where traffic cannot pull entirely off the roadway, for marking of obstructions, and islands which must be passed on the right.

White solid line

A normal solid white line is used to delineate the edge of a travel lane where travel in the same direction is permitted on both sides of the line but crossing the line is discouraged. A white solid line is used for emphasis where crossing requires unusual care.

Double solid white line

A double solid white line is used to delineate a travel lane where travel in the same direction is permitted on both sides of the line, but crossing the double line is prohibited.

Crosswalks

White solid lines are used to denote school and pedestrian crosswalks at intersections and, in some cases, between intersections. A driver must stop at all crosswalks occupied by pedestrians if there are no controlling signals.

Pavement Messages

In some areas, pavement messages are used to warn of conditions ahead, such as SCHOOL ZONE, R/R CROSSING, etc. Such messages are lettered on the road surface in white paint.

Traffic Signs

A thorough knowledge of traffic signs, signals, and road markings is a must for all drivers.

You must know them well enough to recognize them immediately and, in the case of regulatory signs, obey them immediately.

Road signs have taken on a new look with greater use of symbols and pictures. These have the advantage of quicker recognition at high speeds and at greater distance. In addition to becoming familiar with the individual signs, it is important for you to recognize the shapes and colors of signs because both are coded to the signs type of message.

The three types of traffic signs are classified according to function. They are regulatory, warning, and informational.

Other signs can be found on page 55 of this handbook.

School bus safety regulations will be of little avail if drivers fail to observe safe operating practices. If tragedy is to be averted, skill, care, and adherence to the laws must be exercised consistently. In addition, to the safe operation of the school bus, it is the responsibility of the driver to see that the bus and all equipment is in proper working order and maintained at peak efficiency. Cooperation between school bus drivers, school officials, owners, parents, and students is essential in order to assure safe and comfortable transportation.



Remember:

- Do not fuel the bus with occupants aboard.
- No students should be allowed to occupy any position that would interfere with the vision of the driver.
- The school bus driver should not leave the vicinity of the bus when it is occupied by students.
- All doors should be tightly closed at all times when the bus is in motion.
- No bundles, parcels, books, lunch boxes, band or athletic equipment, student projects or the like are allowed in the aisles, blocking the doors, or restricting the driver's vision through the windows.
- Keep the bus comfortable and well ventilated at all times.
- Students should be seated any time the bus is in motion.
- The school bus driver should not transport any animals, firearms, explosives, or anything of a dangerous nature.
- The school bus driver should transport only passengers and approved school supplies and materials designated by the school administration or transportation supervisor. Never transport anything of a dangerous nature.
- Bus drivers should NEVER leave the bus running when unattended.

KNOW THE SIGNS BY THEIR SHAPES AND COLORS.



Test on Bus Operation

True or False

- _____ 1. You must know the approximate size of your bus so you can estimate whether your bus can safely clear structures with restricted width or overhead clearance.
- _____ 2. Drivers tend to underestimate bus length and distance measured in feet.
- _____ 3. Distance and speed estimation for oncoming vehicles at night is almost equal to that of daytime driving.
- _____ 4. You have more help controlling the position of your bus at an intersection in the city than you do in a rural area.
- _____ 5. One of the most common faults of school bus drivers in urban areas is that they do not stay in the proper lane of traffic.
- _____ 6. Blind and uncontrolled intersections are often found on rural roads.
- _____ 7. A basic rule for driving in adverse weather is to decrease your speed.
- _____ 8. In general, when driving on a 4-lane highway you should drive in the right lane except when you need to make a left turn.
- _____ 9. Driving within the posted speed limit is your only concern in adjusting the speed of the bus for urban, rural, residential, or highway driving.
- _____ 10. You may cross a railroad track with the door open to get better visibility.
- _____ 11. Backing should never be done unless it is absolutely necessary and should be done with extreme caution and following proper procedure.
- _____ 12. You should always unload your students before backing your bus to turn around.

Circle the correct answer

13. A safe procedure to follow when rounding a curve is to:
 - a. apply brakes prior to entering the curve, and slightly accelerate at mid point in curve
 - b. coast through the curve
 - c. stop before the curve and then proceed around the curve cautiously
 - d. gradually increase speed prior to entering the curve
14. It is illegal to stop a school bus any closer than _____ feet from a railroad track:
 - a. 15 feet
 - b. 500 feet
 - c. 300 feet
 - d. 20 feet
15. Which of the following should not be a part of the railroad crossing procedure:
 - a. open window
 - b. activate stop sign
 - c. set parking brake
 - d. open door
16. When turning at an intersection without a signal light, you should:
 - a. try to move very carefully through the flow of pedestrians
 - b. try to move through wherever there is a gap in the flow of pedestrians
 - c. wait until there are no pedestrians actually in the intersection waiting to cross
 - d. blow your horn to warn pedestrians
17. What must a driver do before entering a street from an alley, private road, or driveway?
 - a. Slow down and proceed with caution into the flow or traffic
 - b. You do not have to stop
 - c. Stop, yield right of way whether or not there is a stop sign
 - d. Wait until directed to proceed

CONTINUED ON NEXT PAGE

18. A school bus driver who cut the corner too closely when making a right turn, causing the wheels of the bus to go over the curb, probably is:
- unaware that it is happening.
 - a poor judge of distance in other situations, too.
 - trying to save time.
 - none of the above.
19. You are stopped in a line of traffic headed uphill waiting for the light to change. The best way to ensure that the bus does not roll backwards is to:
- keep your foot on the foot brake.
 - accelerate slightly.
 - put the bus in low gear.
 - set the parking brake.
20. Turn signals shall be given continually for at least how many feet before turning.
- 50 feet
 - 100 feet
 - 150 feet
 - 200 feet
21. If at a railroad track you have to wait for a train to pass, when the train passes, what should you do:
- release the parking brake, close the door and proceed?
 - proceed across the tracks with the door open to make sure another train is not approaching?
 - reopen the door, check all tracks again for other trains, when clear, release the parking brake, close door, and proceed with caution?
 - proceed as soon as the warning lights and/or gates are no longer working?
22. In accidents involving fatalities in the loading/unloading zones, most students killed are killed by:
- traffic not stopping for the red flashing lights and stop arm of the school bus.
 - traffic trying to pass the school bus just before it stops.
 - the school bus.
 - traffic entering from a side road.

23. Match the traffic signs below with the correct description.

- _____ 1. Warning
- _____ 2. Stop
- _____ 3. Railroad warning
- _____ 4. Information/location direction
- _____ 5. Yield right of way
- _____ 6. Regulatory
- _____ 7. Railroad crossing
- _____ 8. School zone or school crossing



24. Number the loading events in the correct order with 1 being the first thing to do, then 2 and so on.
- _____ a. Check traffic and turn on yellow warning lights.
 - _____ b. Deactivate red flashing lights.
 - _____ c. Come to a complete stop and activate the red flashing lights and stop sign.
 - _____ d. Open door completely, and allow students to board the bus.
 - _____ e. Engage the parking brake and check mirrors.
 - _____ f. Release the parking brake and check mirrors.
 - _____ g. Close door.

Defensive Driving

The term “defensive driving” is defined as: “Driving to prevent accidents in spite of the incorrect actions of others and adverse weather conditions.” It can also be stated in a formula.

Defensive driving simply means:

Recognize Decide Act
 Potential + on the + in = SAFETY
 Hazards Defense Time

It means that a driver should be aware of the actions of other drivers and be prepared to compensate for their mistakes to avoid an accident. Other drivers often take chances in order to avoid being behind a slow-moving, frequently-stopping school bus. School bus drivers must be aware of this and be prepared to compensate for others’ carelessness. Additionally, statistics indicate that the average driver makes one mistake every quarter mile. Know this and be ready to deal with these mistakes.

One of the most important principles of defensive driving is to **always look ahead and try to avoid dangerous situations.** You can do this if you will practice the defensive driving techniques below.

- 1. Aim high in steering.** Aim your eyesight down the road for an imaginary target in the center of your lane. This is also called “driving ahead of the vehicle.”
- 2. Get the “big picture.”** Get the overall picture of what is going on around you. This includes in front of the bus, on both sides of the bus, and behind the bus.
- 3. Keep your eyes moving.** Don’t fix your eyes on any one object. Looking at one thing tires your eyes and you get to the point where you really don’t see what your eyes are supposed to be “focusing” on. This is a form of “highway hypnosis.” If you form the habit of looking around, it rests your eyes and allows you to see things before you get right up to them. You are better able to “size up” the changing traffic picture and road conditions. “Getting the big picture” includes regular checks of mirrors. Mirrors are likely the most important piece of safety equipment of a school bus. **USE THEM!**

- 4. Leave yourself an “out.”** This is the reason for giving other drivers plenty of warning as to what you are going to do and for not following vehicles too closely.
- 5. Make sure other traffic sees you.** Tap your brakes or flick your headlights. Properly using the signal lights on your bus (eight-ways, turn signals, hazards, etc.) is another way to “make sure other traffic knows what you are going to do.” Hazard lights are another good way to communicate with other drivers. The task of defensive driving is complex. It calls for concentration, reasoning, making decisions, selecting, evaluating, planning, thinking, and many other factors.

Knowledge

Knowledge is a driving quality that is essential if a school bus driver is going to avoid accidents. When a person lacks a thorough knowledge of the hazards involved in driving a school bus or when he lacks sufficient knowledge of the most desirable ways of performing certain skills, his conscious thought is not always an effective deterrent to accidents. In fact, when a driver possesses only partial knowledge of an activity, he is often filled with a false sense of security and can be even more dangerous.

As a school bus driver, your knowledge and application of sound driving practices and skills will determine your driving record. A driver who does not possess knowledge in the following areas must be considered a hazard. Ignorance is a potential hazard and recognition is simple.

Are you knowledgeable in each of these areas?

- State highway laws?
- Local rules and regulations?
- Maintenance procedures?
- Accident and emergency procedures?
- Defensive driving skills?
- First aid?

If not, the time to become knowledgeable in each area is before you drive.

Vehicle Control

You may have to deal with emergencies which, if not handled properly and promptly, could result in an accident. You must know what to do before the situation arises. You must know how to handle your bus so well that, when faced with an emergency situation, you will react almost automatically. Some of these situations include:

Running off the Road

This is not a serious emergency unless you overreact and jerk the steering wheel to get the bus back on the pavement. If you run off the pavement:

- Release the accelerator and allow the bus to slow down gradually.
- Steer straight so that your tires are not rubbing and bumping the edge of the pavement.
- Do not apply the brakes unless there is an object on the roadside you may hit.
- When your speed has been reduced sufficiently to ensure safety, check traffic in both directions and pick an interval in the traffic to return to the pavement.
- Ease the bus onto the pavement without jerking the steering wheel.

Skids

A rear-wheel skid usually occurs when a curve and/or wet section of pavement is encountered at too high a speed. If a rear-wheel skid (or side skid) should occur, simply:

- Do not apply the brakes.
- Decelerate and turn the steering wheel in the direction the rear of the bus is skidding (the direction in which you want to go).

A front-wheel skid can occur when you apply the brakes too heavily, locking them. If a front-wheel skid should occur:

- Release the brakes to allow the vehicle to decelerate.
- Reapply the brakes more carefully after the front wheels begin rolling again.

See page 24 for emergency braking on vehicles with anti-lock brakes.

Vehicle Handling

Vehicle conditions must be considered. Even though buses are basically alike, all of them have peculiarities; they “drive” differently. When a driver is first assigned to drive a bus, the driver should completely familiarize himself/herself with it before moving the bus. He should have no questions about how to operate the bus before pulling out. Feel out the brakes, check what kind of mirrors it has and how they are arranged, what kind of braking system (air, hydraulic, ABS).

No matter how carefully you drive, you must realize that all vehicles, including school buses, are subject to mechanical failures.

Tire Blowout

Consider the possibility of a tire blowout. If a front tire blows out, the bus will pull toward the side of the flat tire. For this reason you should:

- Hold the steering wheel firmly and steer straight.
- Do not apply the brakes.
- Ease off the accelerator to reduce speed.
- Move off the road onto the shoulder, stop, and park.

A rear tire blowout is not as dangerous because buses have dual rear tires. If one does go flat, the other will usually hold the bus upright, allowing the driver to stop safely.

Brake Failure

Another mechanical failure which could cause an accident is brake failure. Most school buses are equipped with dual brake systems, and if one system fails, the other will allow the driver to stop the bus without danger. If the red warning light or buzzer that indicates brake failure comes on, the driver must pull off the road and stop.

On a bus with air brakes, simply apply the parking brake.

If you experience complete brake failure on a non-air brake bus:

- Pump your brake pedal rapidly to build up pressure.
- If pumping does not enable you to stop the bus, downshift to the next lowest gear and set the parking brake.

Sudden Loss of Visibility

Another example where vehicle control is important is where there is a sudden loss of visibility. There are several conditions which can cause such a loss. To control the bus until normal visibility can be restored, you will have to use clues other than the usual visual ones.

If the headlights fail, instantly hit the dimmer switch and activate the four-way hazard lights.

- Try to keep sight of the road.
- Pull off the roadway.
- Brake slowly.
- Stop.

If a large amount of water is splashed on the windshield,

- Remove your foot from the accelerator.
- Turn on the wipers.
- At the same time, cautiously apply the service brake.

In the event of extreme weather conditions,

- Put your lights on low beam.
- Activate four-way flashers (hazard lights).
- Slow down, using the edge lines as guides.
- If the situation is too dangerous, pull off and park as far away from the pavement as possible. Never stop the school bus on the highway.
- Activate strobe light, if equipped.

Object in Path of Bus

Sometimes something may suddenly appear in the path of your bus, such as another vehicle, pedestrian, bicyclist, etc. The thing to remember is that an evasive action should only be taken when the action is safer than a collision. Always remember that you are more likely to avoid hitting anything if the unusual is always anticipated and if effective evasive action is mentally practiced over and over again until it becomes completely automatic. The driver must instantly choose between trying to stop in time or selecting an alternate “escape route” which is free from other, more hazardous obstacles.

Stopping and Following Distance

Stopping a school bus smoothly and within the limits of safety is another sign of a defensive driver. As a defensive driver, you have your vehicle under control at all times and know that braking distances increase greatly as the speed and weight of the bus increases.

Hitting Vehicles Ahead. As a rule, you have much more control over this type of collision than the head-on or rear end collision. Your judgment and driving awareness are much more of a factor because of your road position. As a result, when there is a collision with a vehicle ahead, serious questions concerning your driving must be asked.

Collisions with Vehicles from Behind. Having a collision with a vehicle behind you is no doubt a reflection on your driving habits. Your success at avoiding this kind of accident depends upon your driving practices. If you avoid tailgaters and braking violently and use your signals appropriately, you should not be involved with a collision with vehicles behind you.

Test on Defensive Driving

True or False

- _____ 1. You can use usual and unusual clues to assess how bad a hazard is before you take action.
- _____ 2. You should depend on other drivers to signal their intentions just as you signal.
- _____ 3. The condition of the shoulder of the road should not concern you if you do not intend to pull off the roadway.
- _____ 4. Drivers who do not signal prior to a maneuver are potentially hazardous.
- _____ 5. Lack of communication by other drivers on the road is not a hazard to your safe driving.
- _____ 6. Any point at which the roadway is compressed (for example, a four-lane road narrows into two lanes) represents a conflict point.
- _____ 7. You should always swerve to avoid an animal in the roadway.
- _____ 8. A “panic stop” is always better than no stop at all.
- _____ 9. Two seconds is the minimum time interval to maintain behind a vehicle you are following.
- _____ 10. If your wheels run off the paved surface on a narrow road, you should slow down and turn your wheels gradually to cut back onto the pavement.
- _____ 11. Accidents blamed on skidding or bad weather conditions are classed as “preventable.”
- _____ 12. When driving in snow or ice, you brake while negotiating turns.

- _____ 13. The more intently you fix your central vision on a particular object, the more aware you will be of clues from your larger field of indirect vision.

Multiple Choice

- _____ 14. To detect hazards, you must be able to distinguish _____ within a complex, changing traffic situation.
 - a. clues
 - b. taillights
 - c. accidents
 - d. rules
- _____ 15. Your eyes should scan farther down the roadway as your speed _____.
 - a. decreases.
 - b. stabilizes.
 - c. increases.
 - d. none of the above.
- _____ 16. Many collisions occur at intersections where _____ is obstructed or limited by buildings, vegetation, or parked cars.
 - a. hearing
 - b. stopping
 - c. path
 - d. vision
- _____ 17. Which of these statements is not a good seeing habit when driving a school bus:
 - a. aim high in steering
 - b. get the big picture
 - c. frequently turn around to check on students
 - d. keep your eyes moving
- _____ 18. The purpose of defensive driving is to:
 - a. prevent bodily injury.
 - b. prevent property damage.
 - c. avoid collisions.
 - d. reduce traffic violations.
 - e. all
- _____ 19. When another vehicle is following a school bus too closely, a good defensive driver will avoid:
 - a. sudden stops.
 - b. changing lanes.
 - c. flashing brakelights.
 - d. checking mirrors frequently.

First Aid

The first objective of first aid is to save life. The immediate and temporary care given to the victim of an accident until professional medical assistance is available is called first aid.

You are not expected to be a paramedic; however, you should take a first aid course if/when available.

Four procedures should be followed:

1. Evaluation of the injury and setting priorities for treatment.
2. Maintenance of airway and respiration.
3. Evaluation of bleeding and treatment.
4. Evaluation and control of shock.

It is your responsibility to check the first aid kit on a regular basis to ensure it is properly equipped.

If fire or other immediate danger is present, then all students will be removed from your bus first. Then treat the following injuries at once.

1. **Blocked airway.** The longer you wait, the less chance a person has for survival. Ideally, breathing must be started either on their own or artificially within two minutes.
2. **Bleeding.** If a person is bleeding profusely, you have about two minutes to get the bleeding stopped.
3. **Shock.** Must be treated immediately.
4. **Broken bones.**

Now look at each of the above in more detail.

BLOCKED AIRWAY

Breathing may stop for two reasons:

1. The mouth or windpipe is blocked.
2. The brain center that controls breathing has stopped. The person may turn blue in color, and he may be choking.



The American Heart Association recommends these steps for CPR:

1. Call 911 or ask someone else to do so.
2. Try to get the person to respond; if he doesn't, roll the person on his or her back.
3. Start chest compressions. Place the heel of your hand on the center of the victim's chest. Put your other hand on top of the first with your fingers interlaced.
4. Press down so you compress the chest at least 2 inches in adults and children and 1.5 inches in infants. "One hundred times a minute or even a little faster is optimal," Sayre says. (That's about the same rhythm as the beat of the Bee Gee's song "Stayin' Alive.")
5. If you've been trained in CPR, you can now open the airway with a head tilt and chin lift.
6. Pinch the nose of the victim closed. Take a normal breath, cover the victim's mouth with yours to create an airtight seal, and then give two, one-second breaths as you watch for the chest to rise.
7. Continue compressions and breaths – 30 compressions, two breaths – until help arrives.

Heimlich Maneuver

When an object, usually a piece of food, lodges in the throat so that it prevents breathing, the victim has just four minutes before he will



suffer permanent brain damage from lack of oxygen. A choking victim is unable to breathe or make a sound.

If the victim is conscious, ask him if he can talk. If he can talk and cough effectively, do not interfere with his attempts to clear his throat. Encourage coughing.

If he is unable to make a sound, he is probably choking.

1. Strike the victim sharply, several times in rapid succession between the shoulder blades with the heel of your hand.
2. If the throat remains blocked, use the Heimlich Maneuver. With the victim standing or sitting, wrap your arms around his/her waist from behind. Make a fist with one hand and place it, thumb side down against the abdomen, between the navel and rib cage.
3. Clasp the fist with your free hand and press in with a quick upward thrust. Repeat several times, if necessary.
4. If unsuccessful, repeat blows to the back and the Heimlich Maneuver.

If the victim loses consciousness, continue with treatment for an unconscious victim as follows:

These measures may be used on children and adults. Infants and small children should be held upside down, over the arm of the rescuer, and then struck between the shoulder blades.

If the victim is unconscious and if the cause is unknown, try first to restore breathing using the mouth-to-mouth technique.

If the chest does not rise, treat for choking as follows:

1. Roll the victim on his side, bracing his chest against your knee. Strike him sharply, several times in rapid succession, between the shoulder blades with the heel of your hand.
2. Remove any foreign matter from the mouth and begin mouth-to-mouth breathing.
3. If unsuccessful, kneel close beside the victim's hips and place the heel of one hand on the center of the abdomen, slightly above the navel and below the rib cage. Place your free hand on top of the other.
4. Press in toward the center of the chest with a quick upward thrust. Do not press to either side. Repeat several times if necessary.

5. If vomiting occurs, quickly turn the victim's head to one side. Clear the mouth and begin mouth-to-mouth breathing.

Bleeding

Arterial bleeding — Bright red blood flowing swiftly in spurts or jets.

Venous bleeding — Dark colored blood at a steady flow.

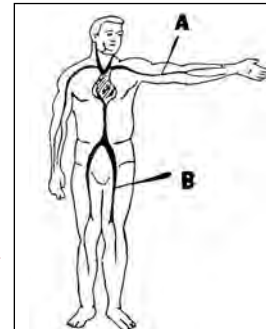

Remember:

- Blood dripping slowly from a wound is generally not serious and can be controlled.
- Blood flowing in a small steady stream may be serious but can be controlled.
- Blood flowing in a heavy stream or in large spurts indicates a serious condition, and you must attempt to bring it under control.

If severe bleeding does not stop after application of direct pressure, the pressure point technique may be required. This technique temporarily compresses the main artery against the underlying bone and nearby tissues and stops circulation to that limb. If the use of a pressure point is necessary, also continue direct pressure of the wound.

Treatment for Shock

Keep victim lying down; maintain body temperature; give fluids only if help is delayed.

Broken Bones

Do not allow victim to be moved until medical help arrives. Keep victim warm and quiet.

Bites and Stings

- Types:** Animal, human and insect.
- Symptoms:** Generally a mark where bitten or stung, swelling, pain, itching and nausea.
- Care:** Wash with soap and water.
- Bee stings — Check with student to see if he is allergic and if he has medicine for it.
- Dog bites — Obtain name of owner of dog and report to authorities.
- Human bites — Likely source of infection. Report to proper authority.

Diabetic

Insulin Shock — too much insulin, not enough sugar.

- a. Rapid onset.
- b. Life threatening.
- c. Confused, shaky, dizzy.
- d. Unconscious.

Care:

- a. Place sugar, jelly from packets or something with sugar under the child's tongue.
- b. Check for medical alert tags.

Coma — too much sugar, not enough insulin; not as dangerous as insulin shock.

- a. Semi-conscious or sleepy.
- b. Air hunger.
- c. Fruity smelling breath.
- d. Flushed face.

Care:

If in doubt, treat for insulin shock. Get medical attention.

First Aid for Epilepsy

1. Keep calm when a major seizure occurs. You cannot stop a seizure once it has started. Do not restrain the patient or try to revive him.
2. Clear the area around them of hard, sharp, hot objects which could injure him. Place a pillow or rolled-up coat under his head.
3. Do not force anything between his teeth.
4. Turn his/her head to one side, and make sure breathing is not obstructed. Loosen tight clothing but do not interfere with his movements.
5. Carefully observe his/her actions during the seizure for a full medical report later. When the seizure is over, let him/her rest if they wish. The proper authorities should be notified of any medical problems.

Test on First Aid

Multiple Choice

- | | |
|---|--|
| <p>_____ 1. Who is expected to check the first aid kit?</p> <ol style="list-style-type: none">a. Supervisorb. State Department of Educationc. Bus driverd. Paramedic <p>_____ 2. When a child is choking and unable to breathe,</p> <ol style="list-style-type: none">a. lay him flat on floor.b. encourage coughing.c. perform the Heimlich Maneuver. | <p>_____ 3. Blood flowing in large spurts:</p> <ol style="list-style-type: none">a. indicates arterial bleeding.b. indicates venous bleeding and is easily controlled.c. demands a tourniquet be applied. <p>_____ 4. Swelling, itching and nausea are usually signs of:</p> <ol style="list-style-type: none">a. diabetic shock.b. an epilepsy seizure.c. an insect bite.d. shock. |
|---|--|

True or False

- _____ 5. A choking victim is unable to breathe or make a sound.
- _____ 6. Blood dripping slowly from a wound is generally easily controlled.
- _____ 7. Direct pressure applied to the wound will usually stop bleeding.
- _____ 8. A student experiencing an epileptic seizure should not have his movements restrained.
- _____ 9. Body temperature should be kept constant for a person in shock.

Accidents, Emergency Stops & Evacuations

What To Do in the Event of an Accident

With careful driving habits, you may never be involved in an accident. However, the fact remains that a percentage of school bus drivers will be involved in an accident sometime in their driving career. Driving defensively will ensure that if you have such an accident, it will more likely be a very minor one.

There are two essentials to your conduct at the scene of an accident:

1. You must get as much information as possible about the accident and report it to the school system.
2. You must be courteous to those involved in the accident, including the police, any witnesses, and to any bystanders with whom they may come in contact.

You are responsible for protecting yourself and the school system by doing nothing that would reflect negatively on your dedication as a professional or on the school system.

Section 32-10-1

(movement of school bus involved in crash)

Accidents involving death or personal injuries.

(a) The driver of any motor vehicle involved in an accident resulting in injury to or the death of any person, or in damage to a motor vehicle or other vehicle which is driven or attended by any person, shall immediately stop such vehicle at the scene of such accident or as close thereto as possible and shall then forthwith return to and in every event shall remain at the scene of the accident until he or she has fulfilled the requirements of Section 32-10-3.

Every such stop shall be made without obstructing traffic more than is necessary.

Always Remember

1. **Stop.** Failure to do so if you are involved is against state law. You could be arrested.
2. **Assist** all injured persons, but do not move them unless their safety is involved. Send someone to call for medical assistance and to call the school system. Be sure to give exact location, extent of injuries, and condition of your passengers.

3. **Protect** the scene and the bus. Set out warning devices as required.
4. **Complete** preliminary accident forms. Get the names and addresses of all witnesses – both for you and against you. Get the license number of any other driver involved.
5. **Be professional.** Give your name, license number and school system name. Do not discuss the accident with anyone except the police and school officials.

*Admit nothing, promise nothing,
and do not argue.*

6. **Do not move the vehicle** until law enforcement officials arrive. (refer to p. 3 Title 32).
Make pictures if possible.
7. **Every accident must be reported to your supervisor. There are no minor accidents involving a school bus! The rules of the State Department of Education require all accidents to be reported to the Alabama State Department of Education.**

Remember the information you need for your accident report:

- Vehicle number, driver's name and address.
 - Date, time, weather, and direction of travel.
 - Damage to vehicle.
 - Name of owner of other vehicle or property, address, license number, make and model of vehicle, and damage to other vehicle.
 - Injuries to persons involved, their names, addresses, extent of injuries.
 - List of passengers on the bus and in other vehicle(s).
 - Names and addresses of passengers in other vehicles.
 - Name of insurance companies involved.
 - Name of police at scene.
 - Diagram of accident scene.
8. **Every accident should be reported to the Alabama Department of Education by the local school system (follow all LEA procedures post accident).**

Emergency Stops

Some situations may occur on the school bus that require the driver to make an emergency stop. Examples of this could be:

- Fight on the bus
- Sick child
- Mechanical issues

Every situation is different, and the driver must make a judgement call to decide the safest action to take. If a school bus driver determines that an emergency stop is necessary, the procedures below should be followed.

Emergency Stop Procedures

- ✓ Search for a safe place to pull completely off the road and activate right turn signal;
- ✓ Once completely and safely off the road and stopped, immediately set the parking brake, place transmission in neutral, activate hazard lights and turn wheels away from the road;
- ✓ When returning to road, release parking brake, place transmission in drive, deactivate hazard lights and activate left turn signal;
- ✓ ALWAYS document unscheduled stops.

Evacuation Drills

In an emergency, it is possible for children to injure each other by everyone trying to get off of the bus at the same time. Federal Guideline 17 provides that evacuation drills be conducted at least twice each school year. Students who are transported in a school vehicle shall participate in these drills. Almost every student will be a passenger during his school career. Evacuation drills should be conducted on the school campus.

Practicing safe and orderly unloading every day is the best way to be prepared for an emergency.

There are three primary ways to evacuate a bus.

1. Everyone exits through the front door.

2. Everyone exits through the emergency exit door (sit and slide).
3. Front half uses the front door and the back half uses the rear emergency exit door.

Using both exits simultaneously is the fastest method of getting students off the bus.

Other emergency exits include emergency windows and roof hatches. However, these emergency exits should be used only when it is not possible to use the front door and the rear emergency door. Examples of this include a bus rollover or fire, or collisions which prohibit the use of the doors.

Any time the bus is in a hazardous position, evacuation should be considered. Evaluate the situation and ask yourself, “Are the students safer away from the bus?”

Example: You would not necessarily evacuate for a flat tire or deep snow, in extreme cold or intense lightning.

The welfare of the students is your main concern.

Hold your evacuation drill on school property, not on your bus route. Have students move 100 feet from the bus and assemble into a group. There is an urgent need, due to the increased number of students being transported and the ever-increasing number of accidents on the highways, to instruct students on how to properly vacate a school bus in case of an emergency. It is possible for students to block the emergency door if all are trying to get out at the same time. There is also a possibility of danger when students jump from an emergency door exit. To avoid these situations, schools should organize and conduct emergency exit drills for all students who ride the school bus on daily routes and on activity trips.

Reasons for Mandatory Emergency Evacuations:

1. **Fire or danger of fire.** Being near an existing fire and unable to move the bus, or being near gasoline or other combustible material is considered to be in danger of fire, and students should be evacuated. The bus should be stopped and evacuated immediately if the engine or any portion of the bus is on fire. Students should be moved to a safe place 100 feet or more from the bus and instructed to remain there until the driver has determined that the danger has passed.

2. **Unsafe bus position.** When the bus is stopped because of an accident, mechanical failure, or road conditions, the driver must determine immediately whether it is safer for students to remain on board or to evacuate the bus. The stopped position of the bus may change and increase the danger (e.g., a bus comes to rest near a body of water or at a precipice where it could still move and go into the water or over a cliff). The driver should be certain that the evacuation is carried out in a manner which affords maximum safety for the students.
3. **Railroad crossings.** The driver must evacuate the bus when the final stopping point is in the path of a train or adjacent to railroad tracks. The stopped position of the bus is such that there is danger of collision.
4. **Sight distance.** In normal traffic conditions, the bus should be visible for a distance of 300 feet or more. A position over a hill or around a curve where such visibility does not exist should be considered reason for evacuation.
5. **Presence of a tornado.** Follow LEA Procedures.

IMPORTANT FACTORS PERTAINING TO SCHOOL BUS EVACUATION DRILLS:

1. Safety of students is of the utmost importance and must be first considered. The bus is secondary to the safety of the passengers.
2. All drills should be supervised by the principal or by persons assigned to act in such a capacity.
3. Written consent from parents or guardians should be obtained before selecting a pupil as a leader.
4. The bus driver is responsible for the safety of the students. When the driver is incapacitated and unable to direct the evacuation, school patrol members, appointed students, or adult monitors should be authorized to direct these drills. It is important to have regular substitutes available.

Pupils selected to assist with evacuation drills should possess the following qualifications:

- a. Maturity.
- b. Good citizenship.
- c. Residence near end of bus route.

Selected students should know how to:

- a. Turn off ignition switch.
 - b. Set emergency brake.
 - c. Summon help when and where needed.
 - d. Open doors and other emergency exits, and account for all students passing his exit.
 - e. Set out reflectors.
 - f. Help younger and disabled students off bus.
 - g. Perform other assignments.
5. Drills should be conducted at beginning of 1st semester and beginning of 2nd semester. Drills should be conducted when the bus arrives at the school campus with the students.
 6. **Drills should be restricted to school property and conducted under the supervision of school officials.**
 7. Types of drills should be varied.
 8. The driver should stay in the bus during evacuation drills. Set the parking brake and turn the ignition off.
 9. Students should not be permitted to take lunch boxes, books, etc., with them when they leave the bus. The objectives are to get students off safely in the shortest time possible and in an orderly fashion.
 10. Students should travel a distance of at least 100 feet from the bus in an emergency drill and remain there until given further directions.
 11. All students and drivers should participate in the drill, including those who ride only on special trips.
 12. All students should be instructed in emergency evacuation drills including students that do not ride on a daily basis.
 13. Students should be instructed in how and where to obtain assistance in emergencies.

SUGGESTED EVACUATION PROCEDURE

1. Park the bus as close to the shoulder of the road as possible.
 - a. Turn hazard lights on.
 - b. Set the parking brake.
 - c. Turn engine off.
2. Stand facing the rear of the bus.
3. Give the command: "Remain seated; prepare to evacuate."

4. Turn toward the front of the bus.
5. Move backwards to the first occupied seat.
6. Starting with either the left or the right seat:
 - a. Touch the shoulder of the person nearest to the aisle to indicate that the passengers in that seat are to move off the bus.
 - b. Keep the passengers in the opposite seat seated by holding the hand, palm out in a restraining gesture, until aisle is clear.
 - c. Move out the passengers in the opposite seat, using the same signal.

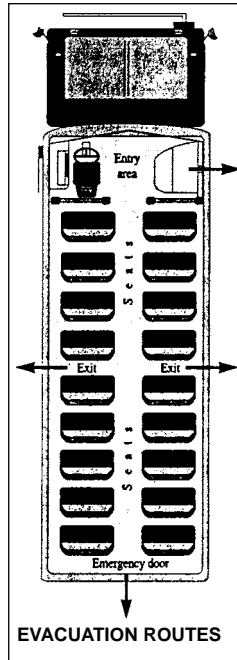

7. Call or have someone call the fire department, the garage, and the school, as necessary. A fire at the front of the bus may make the regular entrance unusable and an alternate route of evacuation necessary. Normally, the front entrance will be available, but the emergency door can be used as the primary exit. Evacuation through both doors is fastest, with the rear monitor working forward seat by seat and the driver working backward seat by seat. Newer buses have emergency window exits on each side. Always evacuate the bus if fuel must be added enroute. Check local policies about special education bus procedures.

GENERAL SAFETY RULES

1. No written procedure can cover every type of emergency that may arise. However, the procedures listed here should be followed as closely as possible.
2. Get students completely out of danger before attempting any other action.
3. Do not endanger yourself by fighting a fire; follow your training to the extent of your training.
4. Do not allow students to re-enter the bus.

Accidents involving death or personal injuries.

- (a) The driver of any motor vehicle involved in an accident resulting in injury to or the death of any person, or in damage to a motor vehicle or other vehicle which is driven or attended by any person, shall immediately stop such vehicle at the scene of such accident or as close thereto as possible and shall then forthwith return to and in every event shall remain at the scene of the accident until he or she has fulfilled the requirements of Section 32-10-3.



*Remember, a bus
can be replaced.
A student can not.*

Test on School Bus Accidents & Emergency Evacuation

True or False

- _____ 1. All school bus collisions must be reported to the local supervisor and to the Alabama State Department of Education.
- _____ 2. All school bus collisions should be reported to the Alabama Department of Education by the local school system.
- _____ 3. When involved in a collision, admit nothing, promise nothing, and do not argue.
- _____ 4. Always assist any injury and move them to a safe place until medical personnel arrive.
- _____ 5. School bus emergency evacuations drills should be conducted beginning of 1st semester and beginning of 2nd semester.
- _____ 6. School bus emergency evacuations drills should be conducted on your route to make it as real as possible.
- _____ 7. During intense lightning or severe weather, you should evacuate the bus and take refuge in a ditch or low-lying area.
- _____ 8. If a school bus is stalled on railroad tracks, evacuate immediately.
- _____ 9. When conducting a rear emergency evacuations drill, older students should sit and slide out of the rear door first to help the younger children.
- _____ 10. There are two primary ways to evacuate a school bus; front door evacuation and rear door evacuation.

Transporting Students with Special Needs

TRANSPORTING STUDENTS WITH SPECIAL NEEDS

Bus drivers should be aware of the fact that virtually every school bus transports students who have some type of disability or special need. However, the vast majority of these students need no special treatment while on the school bus, and should follow the same rules and regulations for bus ridership that apply to other students. In this case, those students will not be identified to the bus driver since their disability does not affect their transportation.

If a student requires any type of special accommodations while on the regular bus, the student's Individualized Education Plan (IEP) or 504 Plan will indicate that Transportation is a "Related Service" and will specify exactly what is needed. These plans are developed annually by a team of school professionals who are knowledgeable about the individual student's needs and available services, along with the parents or guardians of the student (*see Federal Law - IDEA*). Subsequently, the bus driver should be notified and given specific instruction on how to manage the student's needs. In some cases it is necessary for the bus driver to participate in these meetings, in order to develop an appropriate plan for a student.

Examples of special needs a regular bus driver might encounter include the following: (1) medical or health impairment (i.e., diabetes, severe allergies, seizure disorders, or chronic illness); (2) mild physical/orthopedic impairment; (3) speech impairment; (4) hearing impairment; (5) visual impairment; (6) mild intellectual disability; (7) mild autism or Asperger's Syndrome; (8) Attention Deficit Disorder (ADD) or Attention Deficit Hyperactive Disorder (ADHD); and/or (9) other mild behavioral or emotional issues. Accommodations on the bus could include, among others: (1) assistance to board and/or disembark from the school bus; (2) peer helpers; (3) preferential seating; (4) special seating equipment; (5) medical supplies/equipment; (6) a Behavioral Intervention Plan (BIP); (7) additional support personnel, such as an aide; (8) a special emergency evacuation plan; and/or (9) additional driver/aide training. Students with more serious



disabilities are typically placed on a separate, specially-equipped school bus with personnel trained to manage their needs, or other arrangements will be made, according to their IEP.

Do not hesitate to ask for additional information and/or training if you are unsure about how to respond to the needs of a student with a disability on your bus. Remember, however, that all student information is confidential (*See Federal Law - FERPA*). As with all students, any issues that present a safety hazard on the school bus should be reported to administrative staff immediately.

The United Spinal Association has developed a booklet entitled *DISABILITY ETIQUETTE: Tips on Interacting with People with Disabilities*. Some suggestions from that document that might be helpful when transporting students with disabilities could include:

1. Ask before you help. Offer assistance only if the person appears to need it or if they ask for it.
2. Be sensitive about physical contact. Avoid grabbing them, even if your intention is to assist. Instead, offer your arm or other assistance. Remember: People with disabilities consider their equipment part of their personal space. Be respectful.
3. Think before you speak. Talk to them as you would to anyone else.

4. Don't make assumptions. Just because a person has a disability does not mean that they are helpless.
5. Put the person first. Say "student with a disability" rather than "disabled person." Avoid outdated or negative terms like "handicapped" "crippled" or "retarded."
6. Speak clearly and distinctly, and at a normal volume, unless otherwise instructed.
7. People with disabilities are individuals. Their disability alone does not define them.

For more information, please visit www.unitedspinal.org.

FEDERAL SPECIAL EDUCATION LAWS

The **AMERICANS WITH DISABILITIES ACT (ADA)** guarantees equal opportunity for individuals with disabilities, and requires accessibility to all educational services, including transportation.

The **FAMILY EDUCATIONAL RIGHTS AND PRIVACY ACT (FERPA)** protects the privacy of student education records. Bus drivers and bus aides should know that ALL student information is confidential. Information about students should only be discussed with others who have a "need to know" according to the law. Bus drivers can be held personally liable for breach of confidentiality if they disclose personally identifiable information about a student to someone who does not qualify in this category.

The **INDIVIDUALS WITH DISABILITIES EDUCATION ACT (IDEA)** requires public schools to make available to all eligible children with disabilities a free appropriate public education (FAPE) in the least restrictive environment (LRE) appropriate to their individual needs. IDEA requires public school systems to develop an appropriate **Individualized Education Plan (IEP)** for each child. The specific special education and related services outlined in each IEP reflect the individualized needs of each student. IDEA also mandates that particular procedures be followed in the development of the IEP. Each student's IEP must be developed by a team of knowledgeable persons and must be reviewed at least annually.

SECTION 504 OF THE REHABILITATION ACT OF 1973 states that "no qualified individual with a disability in the United States shall be excluded from, denied the benefits of, or be subjected to discrimination under" any program or activity that receives Federal financial assistance. There are some students with a disability who do not qualify for special education services but do qualify for accommodations in the school environment, including the bus, under this law. Those students will have a "504 Plan" detailing those accommodations, and bus drivers will be informed of their special needs. **In addition, no student with a disability may have a shortened school day, unless provided for in the IEP or 504 Plan.** Students with disabilities must be in their classrooms from the beginning bell of the school day until the ending bell of the school day. Students with disabilities may not have a shortened school day due to transportation schedules, administrative convenience, or parent and/or bus driver preferences.

THE SPECIAL NEEDS BUS

Transporting students with disabilities to and from school every day is a huge responsibility. In order to manage the individual needs of their student riders and their equipment, drivers and bus aides must be dedicated, well-trained and well-informed. This often requires participation in the IEP process, as well as routine communication with other IEP team members (i.e., teachers, therapists, nurses, administrators). In addition, bus drivers and aides on a special needs bus may be required to attend training sessions throughout the school year to remain updated on equipment and current practices and procedures.

Most students assigned to the special needs bus are picked up at their home, not at a typical bus stop. This requires a



pre-inspection of the stop by transportation personnel to ensure that the stop is safe and manageable. Routes for special needs buses change often, as children are placed on or removed from the bus. Bus drivers must be flexible and understanding of these changes, and willing to work with transportation administrators to provide safe, efficient routing. In addition, as with any school bus driver, any developing concerns and/or unsafe conditions at the bus stop should be reported to the transportation supervisor immediately.

SPECIALIZED EQUIPMENT

Bus equipped to transport students with disabilities could include the following specialized equipment:

- Lift
- Wheelchair Tie-Down and Occupant Restraint Systems (WTORS)
- Child Safety Restraint Systems (CSRS) and Seat Belts
- Other specialized equipment (i.e., oxygen tanks, wheelchair lap trays, crutches, walkers, canes, medical supplies and equipment) and appropriate securements.
- Accommodation for service animals
- Two (2) seat-belt cutters
- Two (2) emergency evacuation blankets

Additional information can be found in the *Alabama Minimum Specifications for School Buses*.

WHEELCHAIR LIFT OPERATION PROCEDURES

The driver and aide on a special needs bus must be trained on both the electronic and manual operation of the lift, and must perform a pre-trip inspection of the lift prior to each route.

Loading manual wheelchairs:

- Set the emergency brake on the school bus and place the bus in neutral.
- Open the lift-door and secure it to the bus to prevent accidents.
- Push the “unfold” button on the control pad.
- Push the “down” button on the control pad. Release the button as soon as the lift touches the ground to avoid damaging the lift mechanism.

- Make sure that the lift stop plate is in working order.
- **A student loaded on the lift must be seated and secured in a sturdy wheelchair or stroller with operable brakes.**
- **No one should stand while on the lift.**
- Back the wheelchair onto the lift, with the heaviest part of the wheelchair near the bus.
- Ensure that the wheelchair footrest has cleared the raised safety guard on the lift and that the student’s arms and legs are safe.
- Lock the brakes.
- Step away from the lift while maintaining a secure hold on the wheelchair.
- Raise the lift to bus level.
- Release the wheel-chair brake and pull the wheelchair inside the bus.
- Position the wheel-chair in the secure-ment station, **facing forward.**
- Lock the brakes.
- Stow the lift.
- Close and secure the lift door.



Unloading manual wheelchairs:

- Set the emergency brake on the school bus and place the bus in neutral.
- Open the lift-door and secure it to the bus to prevent accidents.
- Push the “unfold” button on the control pad.
- Remove occupant restraints and wheelchair securements, then release the wheelchair brakes.
- Push the wheelchair onto the lift, facing away from the bus.
- Lock the brakes.
- Step away from the lift while maintaining a secure hold on the wheelchair.
- Lower the lift to ground level. Release the button as soon as the lift touches the ground to avoid damaging the lift mechanism.
- Release the wheelchair brake and safely guide the wheelchair off the lift.
- Raise and stow the lift.
- Close and secure the lift door.

Loading Motorized (Powered) Wheelchairs:

- Back the wheelchair onto the lift. A student who is physically and cognitively able may back themselves onto the lift.
- Turn off the power to the wheelchair.
- Secure the manual wheel locks (if present).
- Raise the lift while maintaining a secure hold on the wheelchair.
- When the lift is at bus level, disengage the gears and pull the chair inside the bus. The power may be turned on to maneuver the wheelchair into place for securement.
- Position the wheelchair facing forward.
- Lock the brakes.

Unloading Motorized (Powered) Wheelchairs:

- Release the wheelchair brakes.
- Make sure the power is turned off.
- Disengage the gears and push the wheelchair onto the lift, facing away from the bus.
- Reengage the gears.
- Lock the brakes.
- Lower the lift while maintaining a secure hold on the wheelchair.
- Turn the power on.
- Release the wheelchair brake and safely guide the wheelchair off the lift.
- Raise and stow the lift.
- Close and secure the lift door.

For instructions on securing a wheelchair inside the bus, speak to your supervisor and/or driver trainer.

CHILD SAFETY RESTRAINT SYSTEMS (CSRS)

Some students require the use of a special seating device, called a Child Safety Restraint System. These could include car seats, STAR seats, Pro-Tech seats, PCR seats, Safety Vests, Integrated Child Safety Seats or other devices. The use of such devices requires

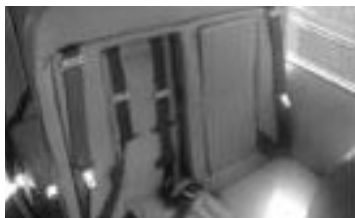

training on the appropriate installation, fit and securement of the device, as well as daily inspection to ensure fitness for use. The website for the National Highway Traffic Safety Administration (NHTSA) contains an excellent training video for the use of CSRS at www.nhtsa.gov.

SEAT BELTS

Some school buses have seat belts installed on their bus bench seats, both of which must meet Federal Motor Vehicle Safety Standards. The term “seat belt” includes both lap belts and lap/shoulder belt systems. If a student’s IEP specifies the use of a seat belt, the driver and aide must be trained on how to properly secure the passenger, ensuring that the lap belt portion of the seat belt is positioned low across the pelvic region near the upper thighs, not across the abdomen of the passenger. The shoulder belt should be positioned diagonally across the middle of the shoulder and the center of the chest and connect to the lap belt near the hip of the passenger. Drivers and aides should receive training on this procedure. **Do not use seat belts to restrain students unless it is specified in their IEP.**

SEAT BELT CUTTERS

In each special needs bus, there must be two (2) seatbelt cutters, one in the driver’s compartment and one in an accessible location towards the rear of the bus. Because many students with disabilities are transported using Child Safety Restraint



Systems (CSRS), seat belts or wheelchairs, the second seat belt cutter will be available to the attendant to expedite the evacuation process, should it be necessary.

Drivers and aides should be trained in their use, and make sure that both cutters are present and accessible when doing the pre-trip inspection of the bus.

EVACUATION BLANKETS

Also required in a special needs bus are two (2) evacuation blankets. These should be mounted on the wall in the rear of the bus, and used to drag students who are non-ambulatory towards the available emergency exit, remove students from the bus and carry or drag them to a safe location. Drivers and aides should be trained on their use and should inspect them regularly.

OTHER SPECIALIZED EQUIPMENT

Other specialized equipment that may be transported and/or used on a special needs bus could include oxygen tanks, wheelchair lap trays, crutches, walkers, canes, and medical supplies and equipment, such as suction machines, diabetic supplies, and seizure and allergy medicines. In addition, service animals may be transported for a student whose disability and IEP require the animal to be in attendance with the student. Proper handling, use, and securement of all specialized equipment is a critical component of employee training which must occur prior to its addition on the school bus.



Please note: The presence of a nurse or other medical professional may also be required for some students with significant health issues.

EMERGENCY EVACUATION OF THE SPECIAL NEEDS BUS

Drivers and aides on special needs buses must devise a written plan for the emergency evacuation of their students prior to the first evacuation drill each year, and must reevaluate the plan each time a student is added or removed from the route. Understanding each student's abilities and disabilities will help in developing a plan that will work. It may be necessary to seek assistance from school personnel (i.e., PT, OT, Nurse, Teacher, Administrator) in the development of the plan for individual students. Evacuation drills must be practiced at least twice per year, once early in the first semester and once early in the second semester. Documents to assist in developing this plan are included in the *Alabama Special Needs School Bus Driver Record & Report Book*.

RECORD-KEEPING

Drivers of special needs buses must complete the documents in the *Alabama Special Needs School Bus Driver Record & Report Book*.

Completion of the reports found in

this book is required by law and must be accurate and true. The "School Bus Monthly Route Report" requires daily documentation of morning unloading times and afternoon loading times of students at each school served, in addition to the student count. The "School Bus Pre-Trip Inspection Record" includes specialty items found in a special needs bus, as well as those on a regular bus. It is important to complete the "Special Needs Student Roster" and the "Special Needs Seating Chart," indicating positions of wheelchairs inside the bus.

When information regarding the special needs of a student assigned to the special needs bus is shared with the bus driver and bus aide, they must sign a document indicating receipt of that information. They must also understand that it is imperative that they protect the privacy of the students assigned to their bus according to FERPA (*See Federal Laws – FERPA*). There must be a local plan in place for the storage of this information.

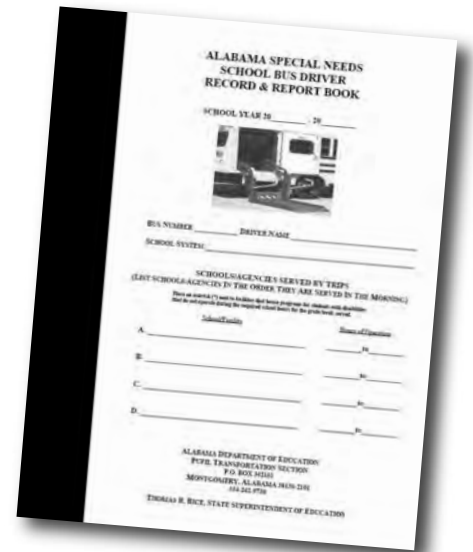

Test on Transporting Students with Special Needs

Multiple Choice

- _____ 1. A special needs bus driver may discuss a child's condition with
- neighbors
 - his/her spouse
 - his/her clergy
 - those that "need to know" as per law
- _____ 2. The letters "IEP" stand for
- Individualized Education Plan/Program
 - Instructional Education Plan
 - Instructions for Exceptional Persons
 - Inservice for Exceptional Program
- _____ 3. Special Needs buses may be equipped with
- a wheelchair lift
 - child safety restraint systems
 - seat belt cutters
 - all of the above
- _____ 4. Where might a school bus driver go online to learn more about Child Safety Restraint Systems?
- Facebook.com
 - ESPN.com
 - nhtsa.gov
 - none of the above
- _____ 5. Emergency evacuation plans for special needs school buses should include:
- a written plan
 - periodic reevaluation of the plan
 - actual practice
 - All of the above









True - False

- _____ 6. It is not important that all forms be completed in the *Alabama Special Needs School Bus Driver Record & Report Book*.
- _____ 7. It is possible that a "Service Animal" accompanies a child while riding the school bus.
- _____ 8. If seatbelts or other types of child safety restraint systems are required for transporting a student, drivers and aides should receive special training.
- _____ 9. All children with disabilities are helpless, therefore it is important that you make informed decisions for their safety.
- _____ 10. Special needs school bus drivers need to be dedicated, well-trained and well-informed.

ALABAMA ROAD SIGNS

It is the language you must know well if you are to drive safely. In recent years, traffic signs throughout the United States have taken on a new look. In many cases symbols and pictorial silhouettes have replaced words. They provide instant communication for those who might have trouble reading or for those who speak another language. It is important to know their shapes and colors.

REGULATORY SIGNS

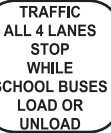
 Stop	 Yield	 Speed Limit 50	 No Left turn	 No Right Turn	 NO TURNS	 No U Turn	 KEEP OFF MEDIAN
 Railroad Crossing	 Left Turn Only	 Thru and Left	 LEFT LANE MUST TURN LEFT	 Double Left Turns	 DO NOT PASS	 PASS WITH CARE	 SLOWER TRAFFIC KEEP RIGHT
 ONE WAY	 ONE WAY	 Keep Left	 Keep Right	 WALK ON LEFT FACING TRAFFIC	 STOP FOR SCHOOL BUS LOADING OR UNLOADING	 RESERVED PARKING MAXIMUM PENALTY \$100	 TRAFFIC ALL 4 LANES STOP WHILE SCHOOL BUSES LOAD OR UNLOAD

CAUTION/WARNING SIGNS

 Signal Ahead	 Merging Traffic	 Lane Drop	 Divided Highway	 Divided Highway Ends	 Two-Way Traffic	 Steep Grade	 Slippery When Wet
 Cattle Crossing	 SCHOOL BUS STOP AHEAD	 12-6"	 NO PASSING ZONE	 School Zone	 School Crossing	 R R	 +
 Right Turn	 Curve Right	 Farm Machinery	 Side Road	 Winding Road	 Stop Ahead	 YIELD AHEAD	 CONSTRUCTION AHEAD

----- Procedures for ----- Loading, Unloading, Railroad Crossings, and Backing

RULES TO LOAD AND UNLOAD STUDENTS

1. The driver should NEVER change stops. Unsafe situations should be reported to the supervisor.
2. Students should load or unload ONLY at their school or designated stop.
3. Stops should be visible at least 500 feet in both directions.
4. Stops should be at least 100 feet from railroad tracks and intersections.
5. Stops on interstate highways are prohibited.
6. Students should NOT cross a median or divided highway.
7. Students should wait on the side of the road on which they live.
8. Students should cross the street 10 feet in FRONT of the bus - NEVER behind the bus.
9. STOPS should always be in the RIGHT, OUTSIDE LANE, NEVER in the left lane (NEVER in a TURN LANE and NEVER WITH A TURN LANE TO THE RIGHT OF THE BUS).
10. Normally, students are safer ON the bus when the bus is backing.
11. Always communicate with students. Use both verbal and non-verbal (hand signals) directives when loading and unloading.

DRIVER PROCEDURE

1. Check traffic, weather and road conditions to determine a safe distance needed to warn traffic of an upcoming stop.
2. Activate yellow warning lights a safe distance (at least 300 feet in rural areas and 100 feet in urban areas).
3. Stop 10 feet before loading or unloading area:
 - a. Activate red flashing lights and stop sign.
 - b. Apply parking brake and check traffic.
 - c. Open door immediately.
4. Students should load in an orderly fashion after the bus stops, all traffic stops and the bus driver signals them to load.
5. Students should be seated before the bus moves.

6. Before moving the bus, the driver must:
 - a. Close door.
 - b. Release parking brake and check all mirrors, especially front crossover and side mirrors.
 - c. Deactivate red flashing lights and stop sign.

During the loading and unloading process, the driver should COUNT the students and move the bus ONLY after ALL students are safely on the side of the road on which they live or in their seats. Be alert for students' apparel or carry-on items being caught on the bus handrail, door, door handle, etc. All students who live on the left side of the road should exit first and cross in single file.

RAILROAD CROSSINGS

1. Check traffic in front and behind the bus. Position the bus in the right lane nearest to the roadside.
2. Activate hazard lights (500 feet is a good "rule of thumb") before the crossing or at the railroad warning sign.
3. Have students trained to be quiet and still. Turn off heaters, defrosters, fans, radio, and open the window.
4. Stop no closer than 15 feet nor farther than 50 feet from the nearest track.
5. Immediately apply parking brake and open door. Look and listen. If train is approaching, close door until it passes.
6. When clear, close door and release parking brake. Never move the bus with the door open.
7. Cross the tracks as quickly and safely as possible.
8. Turn off hazard lights after crossing tracks and resuming normal speed.

BACKING PROCEDURE

1. Helper seated in back seat of bus.
2. Hazard lights.
3. Horn.
4. Check all mirrors constantly and over both shoulders.
5. Back slowly and no farther than necessary.

Always back with students on the bus. Load and then back — back and then unload. Be certain to visually inspect the area behind the bus BEFORE BACKING!

----- Procedures for ----- Conducting Emergency Evacuation

There is an urgent need, due to the increased number of students being transported and the ever-increasing number of accidents on the highways, to instruct students on how to properly vacate a school bus in case of an emergency. It is possible for students to block the emergency door if all are trying to get out at the same time. There is also a possibility of danger when students jump from the rear emergency door exit. To avoid these situations, schools should organize and conduct emergency exit drills for all students who ride the school bus.

Mandatory evacuations:

1. **Fire or danger of fire.** Being near an existing fire and unable to move the bus, or being near the presence of gasoline or other combustible material is considered danger of fire, and students should be evacuated. The bus should be stopped and evacuated immediately if the engine or any portion of the bus is on fire. Students should be moved to a safe place 100 feet or more from the bus and instructed to remain there until the driver has determined that the danger has passed.
2. **Unsafe position of the bus.** When the bus is stopped because of an accident, mechanical failure, road conditions, or human failure, the driver must determine immediately whether it is safer for students to remain on board or to evacuate the bus. The stopped position of the bus may change and increase the danger (e.g., a bus comes to rest near a body of water or at a precipice where it could still move and go into the water or over a cliff). The driver should be certain that the evacuation is carried out in a manner which affords maximum safety for the students.
3. **Railroad tracks.** The driver must evacuate the bus when:
 - a. The final stopping point is in the path of a train or adjacent to railroad tracks.
 - c. The stopped position of the bus is such that there is danger of collision.

4. **Sight distance.** In normal traffic conditions, the bus should be visible for a distance of 300 feet or more. A position over a hill or around a curve where such visibility does not exist should be considered reason for evacuation.

Important factors pertaining to school bus evacuation drills:

1. Safety of students is of the utmost importance and must be first considered.
2. All drills should be supervised by the principal or by persons assigned to act in a supervisory capacity.
3. The bus driver is responsible for the safety of the students. When the driver is incapacitated and unable to direct the evacuation, school patrol members, appointed students or adult monitors should be authorized to direct these drills. It is important to have regular substitutes available. Written consent from parents or guardians should be obtained before assigning a pupil as a leader.

Pupils assigned to assist with evacuation drills should possess the following qualifications:

- a. Maturity
- b. Good citizenship
- c. Residence near end of bus line

Assigned students should know how to:

- a. Turn off ignition switch,
 - b. Set emergency brake,
 - c. Summon help when and where needed,
 - d. Open and close doors, and account for all students passing his exit,
 - e. Help small students off bus, and
 - f. Use radio to contact school officials, and
 - g. Perform other assignments.
4. Drills should be scheduled in a manner similar to fire drills held regularly in schools. They should be held more often during fall and spring months and conducted when the bus arrives at the school building with the students.

5. Drills should be restricted to school property and conducted under the supervision of school officials.
6. Types of drills should be varied.
7. The driver should stay in the bus during evacuation drills. Set the parking brake and turn the ignition off.
8. Students should not be permitted to take lunch boxes, books, etc., with them when they leave the bus. The objectives are to get students off safely in the shortest time possible and in an orderly fashion.
9. Students should travel a distance of at least 100 feet from the bus in an emergency drill and remain there until given further directions.
10. All students should participate in the drill, including those who ride only on special trips.

11. Each student should be instructed in proper safety precautions.
12. Students should be instructed in how and where to obtain assistance in emergencies.

There are three primary drills (see page 45):

1. Everyone exits through the front entrance door(s).
2. Everyone exits through the rear-most emergency door(s).
3. Front half exits through the front door and rear half exits through the rear-most door. (See Diagram)
4. Drivers should always check to see that every student has evacuated the bus.

**72 PASSENGER BUS
(3 students to a seat)**

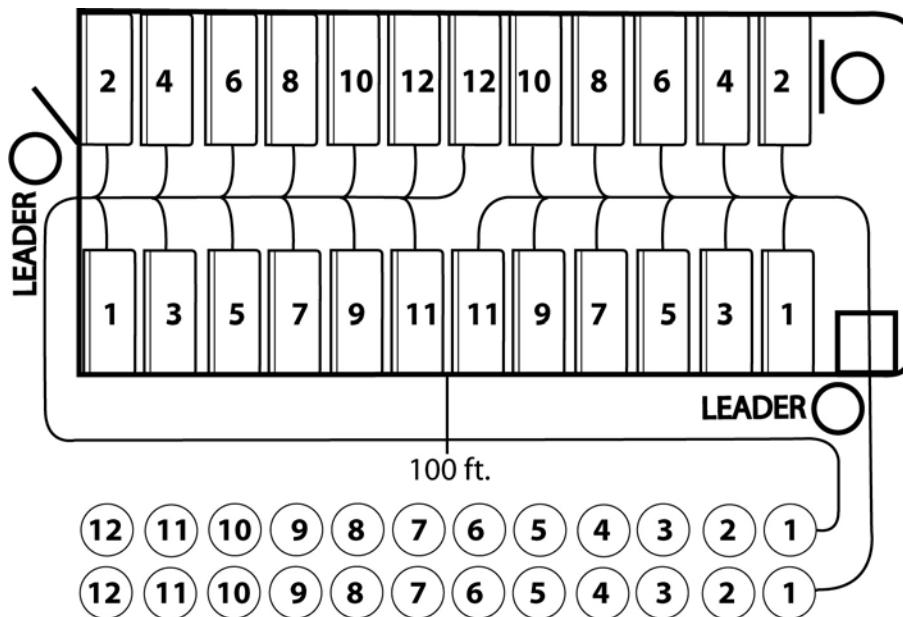

Signs test/Directions: Choose the best answer(s)

Name: _____



- a. Stop
- b. Yield
- c. Route Marker
- d. Information



- a. Stop
- b. Yield
- c. Information
- d. Slow Moving Vehicle

3.



- a. Caution
- b. Route Marker
- c. Railroad Warning
- d. Information

4.



- a. Information
- b. Railroad Crossing
- c. Yield
- d. Warning

5.



- a. Railroad Crossing
- b. Stop
- c. Slow Moving Vehicle
- d. Interstate Sign

6.



- a. Information
- b. Regulatory
- c. Warning
- d. Stop

7.



- a. Stop
- b. Yield
- c. Interstate Sign
- d. Slow Moving Vehicle

8.



- a. Yield
- b. Warning
- c. Regulatory
- d. Information

9.



- a. Construction
- b. Slow Moving Vehicle
- c. Yield
- d. Route Marker

10.



- a. Passing Zone
- b. School Zone
- c. Warning
- d. Regulatory

11.

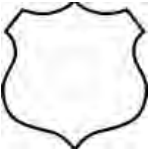

- a. State Route Marker
- b. Stop
- c. Information
- d. US Route Marker

12.



- a. School Zone
- b. Recreation Area
- c. Slow Moving Vehicle
- d. No Passing Zone

13. A red traffic sign means:

- a. Construction
- b. Motorist Services
- c. Information
- d. Stop

17. A green traffic sign means:

- a. Movement Permitted
- b. Caution
- c. Information
- d. Regulatory

14. A yellow traffic sign means:

- a. Construction
- b. Regulatory
- c. Caution
- d. Recreation or Scenic Area

18. An orange traffic sign means:

- a. Construction
- b. Motorist Services
- c. Information
- d. Recreation or Scenic Area

15. A white traffic sign means:

- a. Stop
- b. Regulatory
- c. Motorist Services
- d. Information

19. A brown traffic sign means:

- a. Regulatory
- b. Caution
- c. Recreation or Scenic Area
- d. There are no brown traffic signs

16. A blue traffic sign means:

- a. Caution
- b. Recreation or Scenic Area
- c. Construction
- d. Motorist Services

20. A solid yellow line on the highway means:

- a. A two-lane traffic highway
- b. A no-passing zone
- c. The edge of the pavement
- d. All of the above

Supplemental Questions

1. Name 2 things bus drivers should try to avoid while driving.
2. What should a driver always do before starting, stopping, or turning?
3. When should the driver pull off after unloading students?
4. At what location should drivers load/unload students?
5. What should drivers do if asked to alter a designated stop?
6. What is the recommended speed limit for school bus drivers?
7. Name 3 consistent factors that determine safe driving speed for buses?
8. Name the rules for stopping at a 4-way stop.
9. When do drivers assume right of way?
10. What action should a driver take when traffic begins to build up behind the bus?
11. What action should a driver take if an emergency vehicle approaches?
12. What action should a driver take if signaled to stop by a police officer?
13. Name 2 legal uses of the turn indicator.
14. What part of a rainstorm poses the most danger?
15. What should a route driver do if the warning lights on the bus malfunction?
16. Name 4 things that can automatically fail a student driver.
17. How should an emergency stop be performed?
18. What action should a driver take if a funeral procession is encountered?
19. Does a police officer motioning traffic at an intersection overrule a traffic signal?
20. What action should a driver take if the bus hits a pet while on route?

ALABAMA SCHOOL BUS DRIVER SKILLS TEST

Name _____

System _____

DL# _____ DOB _____

Signature _____ Date _____

<p>EXAMINER CHECKS</p> <input type="checkbox"/> Vehicle Chocked <input type="checkbox"/> Instructions Read <input type="checkbox"/> CDL w/PS <input type="checkbox"/> Used Seat Belt <input type="checkbox"/> Post Trip Bus	<p>Pre-Trip Score _____</p> <p>Basic Control Score _____</p> <p>Road Test Score _____</p> <p>Bus Year/Model _____</p> <p>Bus Tag Number _____</p> <p>GVWR _____</p>
--	---

Class B C Air Brakes Auto Trans. Restrictions: _____ Examiner: _____

PRE-TRIP TEST (49/61 items required to pass)			
<p style="text-align: center;">Front of Bus</p> <p>Light Lenses/Reflectors<input type="checkbox"/></p> <p>Crossing Gate<input type="checkbox"/></p> <p>Leaks<input type="checkbox"/></p> <p>Crossover Mirrors<input type="checkbox"/></p> <p>Wiper Blades & Windshield<input type="checkbox"/></p> <p style="text-align: center;">Engine Compartment</p> <p>Hoses & Wires<input type="checkbox"/></p> <p>Belts (< 3/4")<input type="checkbox"/></p> <p>Oil Level<input type="checkbox"/></p> <p>Transmission Fluid<input type="checkbox"/></p> <p>Power Steering Fluid<input type="checkbox"/></p> <p>Coolant Level<input type="checkbox"/></p> <p>Steering Linkage<input type="checkbox"/></p> <p>Steering Box<input type="checkbox"/></p> <p>Springs<input type="checkbox"/></p> <p>Mounts & U Bolts<input type="checkbox"/></p> <p>Shock Absorber<input type="checkbox"/></p> <p>Brake Hose<input type="checkbox"/></p> <p>Brake Chamber or Caliper<input type="checkbox"/></p> <p>Slack Adjuster/Push Rod<input type="checkbox"/></p> <p>Brake Drum/Lining or Rotor/Pad<input type="checkbox"/></p> <p>Tire (I-C-D)<input type="checkbox"/></p> <p>Rim<input type="checkbox"/></p> <p>Lug Nuts<input type="checkbox"/></p> <p>Hub Oil Seal<input type="checkbox"/></p> <p>Number of Errors _____</p>	<p style="text-align: center;">Driver Side</p> <p>Side Mirrors<input type="checkbox"/></p> <p>Stop Sign<input type="checkbox"/></p> <p>Side Reflectors<input type="checkbox"/></p> <p>Battery<input type="checkbox"/></p> <p>Frame<input type="checkbox"/></p> <p>Drive Shaft<input type="checkbox"/></p> <p>Exhaust<input type="checkbox"/></p> <p style="text-align: center;">Driver Rear</p> <p>Springs<input type="checkbox"/></p> <p>Mounts & U Bolts<input type="checkbox"/></p> <p>Shock Absorber or Air Bag<input type="checkbox"/></p> <p>Brake Hose<input type="checkbox"/></p> <p>Brake Chamber or Caliper<input type="checkbox"/></p> <p>Slack Adjuster/Push Rod<input type="checkbox"/></p> <p>Brake Drum/Lining or Rotor/Pad<input type="checkbox"/></p> <p>Tire Space<input type="checkbox"/></p> <p>Tire (I-C-D)<input type="checkbox"/></p> <p>Rim<input type="checkbox"/></p> <p>Lug Nuts<input type="checkbox"/></p> <p>Axle Seals<input type="checkbox"/></p> <p>Splash Guards<input type="checkbox"/></p> <p style="text-align: center;">Back of Bus</p> <p>Light Lenses/Reflectors<input type="checkbox"/></p> <p>Emergency Door<input type="checkbox"/></p> <p>Number of Errors _____</p>	<p style="text-align: center;">Passenger Side</p> <p>Fuel Area (Cap & Cage & Leaks)<input type="checkbox"/></p> <p>Storage Compartment<input type="checkbox"/></p> <p>DEF Cap/Level<input type="checkbox"/></p> <p style="text-align: center;">Passenger Entry</p> <p>No Trespass Sign<input type="checkbox"/></p> <p>Door (Function & Cond.)<input type="checkbox"/></p> <p>Entry Steps & Stepwell Light<input type="checkbox"/></p> <p style="text-align: center;">Driver's Seat Area (Engine Off)</p> <p>Safety & Emergency Items (4)<input type="checkbox"/></p> <p>Seatbelt<input type="checkbox"/></p> <p>Steering Play & Horn<input type="checkbox"/></p> <p style="text-align: center;">(Engine On)</p> <p>Gauges (4): Oil/Volt/Temp/Air<input type="checkbox"/></p> <p>Switches (3): Wipers/Heater/Defrost<input type="checkbox"/></p> <p>Pass. Seats/Emer. Exits<input type="checkbox"/></p> <p>Lighting Indicators (4): L/R/Haz/DEF<input type="checkbox"/></p> <p>Number of Errors _____</p>	<p style="text-align: center;">Air Brake Check</p> <p>Driver Initiated Fail <input type="checkbox"/> Pass <input type="checkbox"/></p> <ol style="list-style-type: none"> Check for Leaks 2-3 psi Bleed Pressure Down Red Low Air Warning Light/ Low Air Buzzer Sounds @ 60 psi Pressure Valve Pops Emergency Brake Check Parking Brake Check Service Brake Check <p><i>*Driver must master all air brake check items to pass pre-trip inspection.</i></p> <p>Hydraulic Brake Check <input type="checkbox"/></p> <p style="text-align: center;">Light Operation Check<input type="checkbox"/></p> <p>Driver Initiated</p> <ol style="list-style-type: none"> Yellow & Red Warning (Front and Back) Stop Sign & Crossgate Turn Signals (Front and Back) Hazard Lights (Front and Back) Head Lights (High & Low) Clearance/Strobe Lights Back-Up/Tail Lights Brake Lights <p>Number of Errors _____</p>

BASIC CONTROL SKILLS TEST		
<p style="text-align: center;">Straight Backing (1 Pull-up)</p> <p>Pull-Ups 1 <input type="checkbox"/> Pass <input type="checkbox"/> Fail</p> <p>Look 1</p> <p>Vehicle Control <input type="checkbox"/> Pass <input type="checkbox"/> Fail</p> <p>Help & Hazard & Horn <input type="checkbox"/> Yes <input type="checkbox"/> No</p> <p>Final Score<input type="checkbox"/> Pass <input type="checkbox"/> Fail</p>	<p style="text-align: center;">Offset Backing (2 Pull-ups)</p> <p>Pull-Ups 1 2 <input type="checkbox"/> Pass <input type="checkbox"/> Fail</p> <p>Look 1 2</p> <p>Vehicle Control <input type="checkbox"/> Pass <input type="checkbox"/> Fail</p> <p>Help & Hazard & Horn <input type="checkbox"/> Yes <input type="checkbox"/> No</p> <p>Front Bumper Position <input type="checkbox"/> Pass <input type="checkbox"/> Fail</p> <p>Final Score<input type="checkbox"/> Pass <input type="checkbox"/> Fail</p>	<p style="text-align: center;">Alley Dock (2 Pull-ups)</p> <p>Pull-Ups 1 2 <input type="checkbox"/> Pass <input type="checkbox"/> Fail</p> <p>Look 1 2</p> <p>Vehicle Control <input type="checkbox"/> Pass <input type="checkbox"/> Fail</p> <p>Help & Hazard & Horn <input type="checkbox"/> Yes <input type="checkbox"/> No</p> <p>Rear Stop Line <input type="checkbox"/> Pass <input type="checkbox"/> Fail</p> <p>Final Score<input type="checkbox"/> Pass <input type="checkbox"/> Fail</p>

ROAD TEST (10 errors or less required to pass)			
<p style="text-align: center;">Bridges/Signs (2) ¹ <input type="checkbox"/> ² <input type="checkbox"/></p> <p>Left Lane Changes (2) Right</p> <p><input type="checkbox"/>Traffic Check.....<input type="checkbox"/></p> <p><input type="checkbox"/>Signal.....<input type="checkbox"/></p> <p><input type="checkbox"/>Spacing.....<input type="checkbox"/></p> <p><input type="checkbox"/>Smooth Change.....<input type="checkbox"/></p> <p><input type="checkbox"/>Cancel Signal.....<input type="checkbox"/></p> <p>Left Graded Curve (2) Right</p> <p><input type="checkbox"/>Improper Speed.....<input type="checkbox"/></p> <p><input type="checkbox"/>Improper Lane.....<input type="checkbox"/></p> <p><input type="checkbox"/>Improper Braking.....<input type="checkbox"/></p> <p><input type="checkbox"/>Improper Traffic Check.....<input type="checkbox"/></p>	<p style="text-align: center;">Intersections</p> <p>Stop 1 2 Through 1 2</p> <p><input type="checkbox"/>Traffic Check.....<input type="checkbox"/></p> <p><input type="checkbox"/>Braking.....<input type="checkbox"/></p> <p><input type="checkbox"/>Placement.....<input type="checkbox"/></p> <p><input type="checkbox"/>Driving Through.....<input type="checkbox"/></p> <p><input type="checkbox"/>Yield. Lane. Gear.....<input type="checkbox"/></p> <p><input type="checkbox"/>Accelerate.....<input type="checkbox"/></p> <p>Left Graded Turns Right</p> <p>1 2 3 4 1 2 3 4</p> <p><input type="checkbox"/>Signal.....<input type="checkbox"/></p> <p><input type="checkbox"/>Lane.....<input type="checkbox"/></p> <p><input type="checkbox"/>Speed.....<input type="checkbox"/></p> <p><input type="checkbox"/>Traffic Check.....<input type="checkbox"/></p> <p><input type="checkbox"/>Turn.....<input type="checkbox"/></p>	<p style="text-align: center;">Passenger Load/Unload</p> <p>Load Unload</p> <p><input type="checkbox"/>Traffic & Mirror Check.....<input type="checkbox"/></p> <p><input type="checkbox"/>Yellow Warning Lights.....<input type="checkbox"/></p> <p><input type="checkbox"/>Use of Service Brake.....<input type="checkbox"/></p> <p><input type="checkbox"/>Vehicle Position.....<input type="checkbox"/></p> <p><input type="checkbox"/>Red Lights & Stop Arm.....<input type="checkbox"/></p> <p><input type="checkbox"/>Door Control & Traffic Check.....<input type="checkbox"/></p> <p><input type="checkbox"/>Parking Brake.....<input type="checkbox"/></p> <p><input type="checkbox"/>Student Checks & Comm.....<input type="checkbox"/></p> <p style="text-align: center;">Emergency Road Side Stop</p> <p><input type="checkbox"/> Traffic Check <input type="checkbox"/> Park Brake</p> <p><input type="checkbox"/> Improper Signal Use <input type="checkbox"/> Shift into Neutral</p> <p><input type="checkbox"/> Hazard Lights <input type="checkbox"/> Return to Traffic</p>	<p style="text-align: center;">General Driving Behavior</p> <p>Urban 1 2 3 4 5 Rural 1 2 3 4 5</p> <p><input type="checkbox"/>Improper Use of Brakes.....<input type="checkbox"/></p> <p><input type="checkbox"/>Improper Hand Steering.....<input type="checkbox"/></p> <p><input type="checkbox"/>Disobeyed Signs & Signals.....<input type="checkbox"/></p> <p style="text-align: center;">Put Vehicle Over Curb, Lanes</p> <p>1 2 3 4 5 1 2 3 4 5</p> <p><input type="checkbox"/>Stop Line, Shoulders.....<input type="checkbox"/></p> <p>1 2 3 4 5 1 2 3 4 5</p> <p><input type="checkbox"/>Speed & Following Distance.....<input type="checkbox"/></p> <p>1 2 3 4 5 1 2 3 4 5</p> <p><input type="checkbox"/>Failure to Select Proper Lane.....<input type="checkbox"/></p> <p>1 2 3 4 5 1 2 3 4 5</p> <p><input type="checkbox"/>Failure to Check Traffic.....<input type="checkbox"/></p> <p>1 2 3 4 5 1 2 3 4 5</p> <p><input type="checkbox"/>Improper Vehicle Position.....<input type="checkbox"/></p>
<p>Railroad Crossing <input type="checkbox"/> Hazard Lights <input type="checkbox"/> Observation & Noisemakers <input type="checkbox"/> Placement <input type="checkbox"/> Door & Window <input type="checkbox"/> Parking Brake</p>			

Alabama School Bus Driver Certification Examination

Name: _____

Form: _____

Date: _____

School System: _____

Lic #: _____

- 1. (A) (B) (C) (D)
- 2. (A) (B) (C) (D)
- 3. (A) (B) (C) (D)
- 4. (A) (B) (C) (D)
- 5. (A) (B) (C) (D)
- 6. (A) (B) (C) (D)
- 7. (A) (B) (C) (D)
- 8. (A) (B) (C) (D)
- 9. (A) (B) (C) (D)
- 10. (A) (B) (C) (D)
- 11. (A) (B) (C) (D)
- 12. (A) (B) (C) (D)
- 13. (A) (B) (C) (D)
- 14. (A) (B) (C) (D)
- 15. (A) (B) (C) (D)
- 16. (A) (B) (C) (D)
- 17. (A) (B) (C) (D)
- 18. (A) (B) (C) (D)
- 19. (A) (B) (C) (D)
- 20. (A) (B) (C) (D)
- 21. (A) (B) (C) (D)
- 22. (A) (B) (C) (D)
- 23. (A) (B) (C) (D)
- 24. (A) (B) (C) (D)
- 25. (A) (B) (C) (D)
- 26. (A) (B) (C) (D)
- 27. (A) (B) (C) (D)
- 28. (A) (B) (C) (D)
- 29. (A) (B) (C) (D)
- 30. (A) (B) (C) (D)
- 31. (A) (B) (C) (D)
- 32. (A) (B) (C) (D)
- 33. (A) (B) (C) (D)
- 34. (A) (B) (C) (D)
- 35. (A) (B) (C) (D)
- 36. (A) (B) (C) (D)
- 37. (A) (B) (C) (D)
- 38. (A) (B) (C) (D)
- 39. (A) (B) (C) (D)
- 40. (A) (B) (C) (D)
- 41. (A) (B) (C) (D)
- 42. (A) (B) (C) (D)
- 43. (A) (B) (C) (D)
- 44. (A) (B) (C) (D)
- 45. (A) (B) (C) (D)
- 46. (A) (B) (C) (D)
- 47. (A) (B) (C) (D)
- 48. (A) (B) (C) (D)
- 49. (A) (B) (C) (D)
- 50. (A) (B) (C) (D)

ALABAMA STATE DEPARTMENT OF EDUCATION
Basic Controls Skills Test
Course Layout

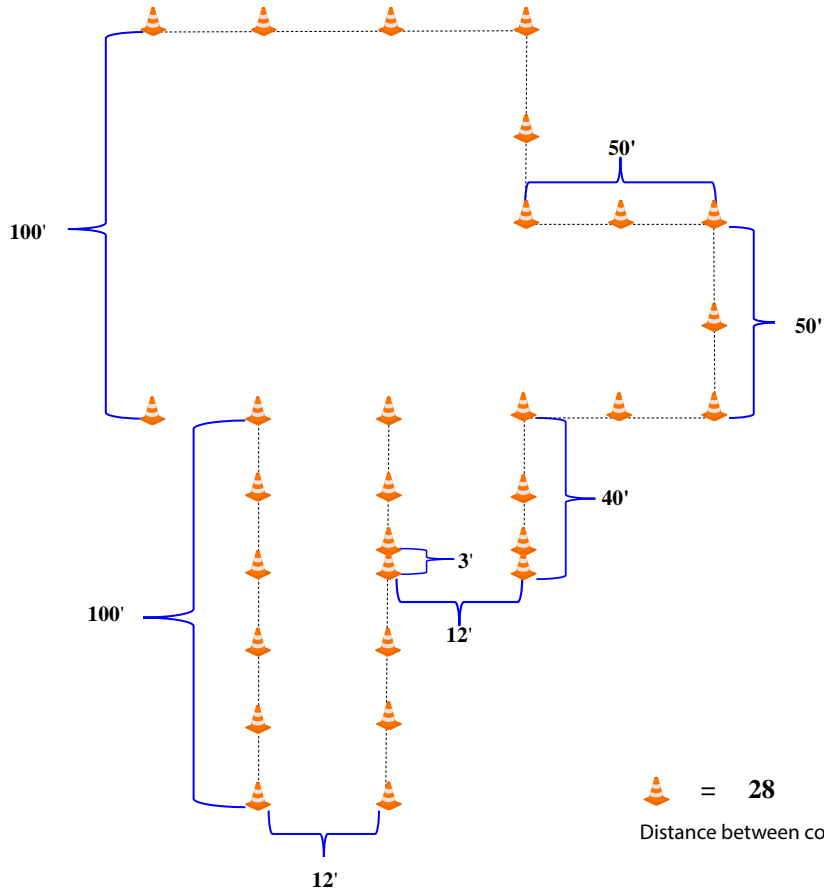

As a School Bus Driver



*You Transport
the Most Precious Cargo.*